

# B70(71) BRONZE (IRON) SELF - LUBRICATED POROUS BEARINGS

## BRONZOVÉ (ŽELEZNÉ) SAMOMAZNÉ PÓROVITÉ LOŽISKÁ

### Type A Cylindrical

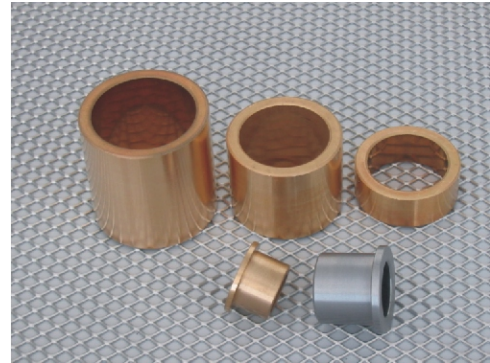
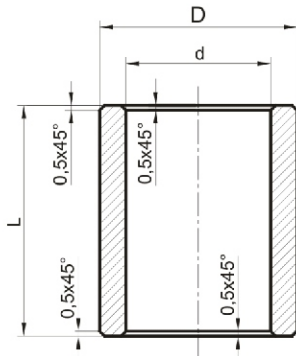

Unit:mm

Pre-fitting diameter		Lengths
ød (G7)	øD (s7)	L (Tolerance j13)
2	5	2-3
3	6	4-5-6-10
4	8	4-5-6-8-10-12
5	8	5-8-10-12-15-16
5	10	5-6-8-10-12-15
6	9	4-6-10-12-16
6	10	4-5-6-10-12-15-
6	12	5-6-8-10-12-15-16
7	10	5-8-10
8	11	6-8-12-16-20
8	12	8-10-12-15-16-20
8	14	8-10-12-15-16-20
9	14	10-12-15-20
10	14	8-10-16-20-25
10	15	10-12-15-16-20-25
10	16	8-10-12-15-16-20-25
10	18	10-12-15-20-25
12	15	10-12-15-16-20-25
12	16	8-10-12-15-16-20-25
12	17	12-15-16-20-25
12	18	8-10-12-15-16-20-25-30
12	20	12-15-20-25-30
14	18	10-14-15-18-20-22-25-28
14	20	10-12-14-15-18-20-22-25-28-30
15	20	10-12-15-20-25-30
15	21	10-15-16-20-25-32
15	22	15-16-20-25-30
16	20	12-15-16-20-25-30-32
16	22	12-15-16-20-25-30-32-35
18	22	12-15-18-20-22-25-28-30-36
18	24	12-18-22-28-30-36
18	25	16-18-20-22-25-28-30-35-36
20	24	16-20-25-32
20	25	15-16-20-25-30-32-35
20	26	15-16-20-25-30-32-35-40
20	28	16-20-25-30-32-35-40
20	30	20-25-30-35-40
22	27	15-18-20-22-25-28-30-35-36-40
22	28	18-20-22-25-28-30-35-36-40

Pre-fitting diameter		Lengths
ød (G7)	øD (s7)	L (Tolerance j13)
25	30	20-25-30-32-35-40
25	32	20-25-30-32-35-40-45
25	35	25-30-35-40-45-50
28	32	20-22-25-28-32-36-40
28	33	20-22-25-28-32-36-40-45
28	35	25-30-35-40-45-50
28	36	22-28-36-45
30	35	20-25-30-35-40-45-50
30	38	20-24-25-30-35-38-40-45-50
30	40	20-25-30-35-40-45-50
32	38	20-25-32-40-50
32	40	20-25-30-32-35-40-45-50
35	40	20-25-30-35-40-45-50
35	44	22-28-35
35	45	25-30-35-40-45-50-60
36	42	22-28-36-45
36	45	22-28-36-45
38	44	25-35-45
40	45	35-40-45-50
40	46	25-30-32-40-50
40	50	25-32-40-45-50-60
45	51	28-36-45-56
45	55	30-35-40-45-50-55-60
45	60	40-45-50-60
50	56	32-40-50-63
50	60	32-40-45-50-60
55	65	40-55-70
60	70	50-60-90-120
60	72	50-60-70
60	80	90-120
70	80	90-120
80	100	80-120
100	120	80-120

Order example: **B70-A-10-13-25**

material: bronze  
 type: cylindrical



# B70(71) BRONZE (IRON) SELF - LUBRICATED POROUS BEARINGS BRONZOVÉ (ŽELEZNÉ) SAMOMAZNÉ PÓROVITÉ LOŽISKÁ

## Type B Flanged

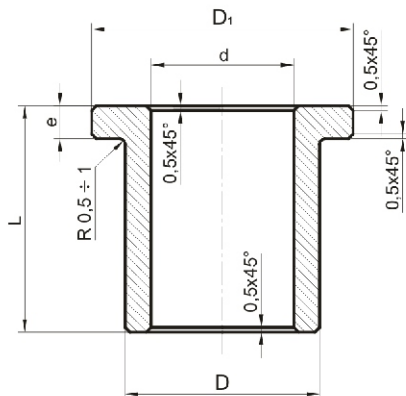

Unit:mm

Pre-fitting diameter		Flanged		Lengths
∅d (G8)	∅D (s8)	D <sub>1</sub>	e	L (Tolerance j13)
3	6	9	1,5	4-5-6-10
4	8	12	2	4-5-8-10-12
6	10	14	2	6-10-15-16
8	12	16	2	8-10-12-15-16
9	14	19	2,5	6-10-14
10	14	18	2	10-15-20
10	15	20	3	10-15-16-20
10	16	22	3	8-10-16
12	17	22	3	10-12-15-16-20-25
12	18	24	3	8-12-20
14	20	25	3	14-15-18-20-22-25-30
15	20	25	3	15-20-25-30
15	21	27	3	16-20-25-32
16	22	28	3	15-16-20-25-30-32
18	22	26	2	18-22-28
18	24	30	3	18-22-28
18	25	32	4	20-25-30-35
20	24	28	2	10-16-20-25
20	26	32	3	15-16-20-25-30-32
20	28	35	4	20-25-30-35
22	28	33	4	15-20-25-30-35-40
25	30	35	2,5	20-25-32
25	32	40	4	20-25-30-32-35-40
25	35	45	5	16-25-30
28	36	44	4	22-25-28-30-35-36-40
30	38	46	4	20-25-30
30	40	48	4	25-30-35-40
32	38	44	3	20-25-32
32	40	48	4	20-25-30-32-35-40
35	45	55	5	20-25-30-35-40
36	45	54	4,5	22-28-36
40	46	52	3	25-32-40
40	50	60	5	25-30-32-35-40
45	51	57	3	28-36-45
45	56	67	5,5	28-36-45
50	56	62	3	32-40-50
50	60	70	5	32-40-50
60	70	80	5	50-60

## Type C Spherical

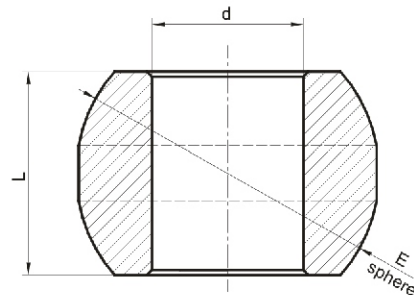

Unit:mm

d inner	E sphere	Lengths - L
H7	± 0,05	± 0,15
4	10	8
5	12	9
6	14	11
7	16	12
8	18	13
9	20	14,5
10	22	16
12	23	16

Order example: **B70-C-6-14-11**  
 material: bronze  
 type: spherical

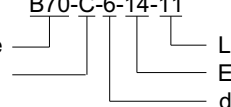

Order example: **B70-B 15-20-30**  
 material: bronze  
 type: flanged

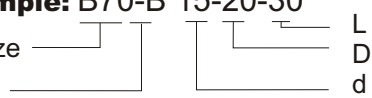

## **B70(71)** BRONZE (IRON) SELF - LUBRICATED POROUS BEARINGS BRONZOVÉ (ŽELEZNÉ) SAMOMAZNÉ PÓROVITÉ LOŽISKÁ

The Self - lubricating Bronze Bearings made from sintered powders, offer:

### **Safety:**

- Elimination of the risk of seizure
- Permanent lubrication film
- 20 to 30% of the volume is oil impregnated
- Quiet function
- Low friction coefficient

### **Economy:**

- Elimination of lubricators
- Maintenance-free
- Permanent stock

### **Technology:**

- Very high precision
- Loads up to 200 Kg./cm<sup>2</sup>
- Speeds up to 30.000 r.p.m.
- Temperatures from -20°C to +120°C

### **Impregnation oil:**

- ISO-VG-68 viscosity paraffinic mineral oil

### **Allowable load**

- PV = 2,5MPa.m/s

It is also possible to manufacture bearings with different sizes, materials and lubricants than those indicated in this catalogue.

### **Application of Self - lubricating bearings:**

Sewing machines, locks, fans, electric watches, washing machines - agitators - water pumps, garage doors, portable machine tools, machinery for wood, bottling machinery, gardening machines, toys, shaving machines, high and low power electrical motors, automotive equipment such as alternators, service break pedals, door hinges, speed counters, windscreen wiper motors, heating motors, etc.

Bronzové (železné) samomazné pórovité ložiská zo spekaných práškov ponúkajú:

### **Spoľahlivosť:**

- eliminujú riziko zadretia
- stály mazací film
- 20 - 30% objemu je nasiaknutého olejom
- tichý chod
- nízky koeficient trenia

### **Ekonomiku:**

- nevyžadujú mazanie
- nevyžadujú údržbu
- stála zásoba na sklade

### **Technika:**

- veľmi vysoká presnosť
- zaťaženie do 200 kg/cm<sup>2</sup>
- otáčky do 30.000 ot/min.
- teploty od -20°C do +120°C

### **Impregnačný olej:**

- ISO-VG-68 viskózný parafínový minerálny olej

### **Dovolené zaťaženie:**

- PV = 2,5MPa.m/s

Je tiež možné vyrobiť ložiská s inými rozmermi, z iného materiálu a s iným mazadlom, ako boli uvedené v tomto katalógu

### **Použitie:**

Šijacie stroje, zámky, ventilátory, elektrické hodiny, práčky - bubon - vodná pumpa, garážové dvere, prenosné mechanické náradie, lesné stroje, plnace stroje, záhradná mechanizácia, hračky, holiace strojčky, nízko aj vysokovýkonné el. motory, automobilové príslušenstvo ako alternátory, brzdové spojkové pedály, pánty dverí, tachometre, motorčky stieračov a kúrenie atď.