

Inch series

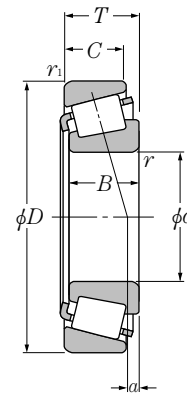

d 12.700 ~ 22.225mm

d	Boundary dimensions				dynamic kN	Basic load ratings		dynamic kgf	static kgf	Limiting speeds	
	D	T	B	C		static	dynamic			grease	oil
12.700	34.988	10.998	10.988	8.730	12.3	11.6	1 260	1 180	12 000	16 000	
14.989	34.988	10.998	10.988	8.730	12.3	11.6	1 260	1 180	12 000	16 000	
15.875	41.275	14.288	14.681	11.112	20.3	18.7	2 070	1 910	10 000	13 000	
	42.862	14.288	14.288	9.525	17.6	17.5	1 800	1 790	8 700	12 000	
	42.862	16.670	16.670	13.495	26.7	26.0	2 720	2 650	9 800	13 000	
	47.000	14.381	14.381	11.112	24.0	24.2	2 440	2 460	8 600	11 000	
	49.225	19.845	21.539	14.288	38.5	39.0	3 900	3 950	8 500	11 000	
16.993	47.000	14.381	14.381	11.112	24.0	24.2	2 440	2 460	8 600	11 000	
17.462	39.878	13.843	14.605	10.668	23.8	24.2	2 420	2 470	10 000	13 000	
19.050	39.992	12.014	11.153	9.525	12.8	12.8	1 310	1 300	10 000	13 000	
	45.237	15.494	16.637	12.065	28.3	28.6	2 880	2 920	8 900	12 000	
	47.000	14.381	14.381	11.112	24.0	24.2	2 440	2 460	8 600	11 000	
	49.225	18.034	19.050	14.288	38.5	39.0	3 900	3 950	8 500	11 000	
	49.225	19.845	21.539	14.288	38.5	39.0	3 900	3 950	8 500	11 000	
	49.225	21.209	19.050	17.462	38.5	39.0	3 900	3 950	8 500	11 000	
	53.975	22.225	21.839	15.875	40.0	39.0	4 100	3 950	8 000	11 000	
56.896	19.368	19.837	15.875	42.5	46.5	4 350	4 750	7 200	9 600		
19.987	47.000	14.381	14.381	11.112	24.0	24.2	2 440	2 460	8 600	11 000	
20.000	50.005	13.495	14.260	9.525	26.0	27.9	2 650	2 850	7 500	10 000	
20.625	49.225	19.845	21.539	14.288	38.5	39.0	3 900	3 950	8 500	11 000	
20.638	49.225	19.845	19.845	15.875	37.5	39.0	3 800	3 950	8 200	11 000	
21.430	50.005	17.526	18.288	13.970	38.0	39.0	3 850	3 950	8 000	11 000	
21.986	45.974	15.494	16.637	12.065	29.6	34.0	3 000	3 450	8 400	11 000	
22.225	50.005	13.495	14.260	9.525	26.0	27.9	2 650	2 850	7 500	10 000	
	50.005	17.526	18.288	13.970	38.0	39.0	3 850	3 950	8 000	11 000	
	52.388	19.368	20.168	14.288	40.5	43.0	4 150	4 350	7 600	10 000	
	53.975	19.368	20.168	14.288	40.5	43.0	4 150	4 350	7 600	10 000	

Note: 1. Chamfer dimensions on the back face of the inner and outer rings of the bearing are larger than maximum values for installation dimensions r_{1as} and r_{2as} .
 2. As for the maximum value for inner and outer ring diameters of bearings whose bearing numbers are marked with "+" (inner ring) and "++" (outer ring), the precision class is an integer for class 4 and class 2 bearings only.

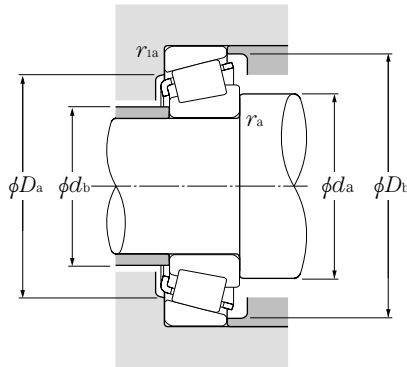

Equivalent radial load dynamic

$$P_r = XF_r + YF_a$$

$\frac{F_a}{F_r} \leq e$		$\frac{F_a}{F_r} > e$	
X	Y	X	Y
1	0	0.4	Y ₂

static

$$P_{or} = 0.5F_r + Y_0F_a$$

When $P_{or} < F_r$ use $P_{or} = F_r$

For values of e , Y_2 and Y_0 see the table below.

Bearing numbers	Abutment and fillet dimensions						Load center mm	Constant e	Axial load factors		Mass kg (approx.)
	mm								a	e	
	d_a	d_b	D_a	D_b	r_{as} max	r_{1as} max					
4T-A4050/A4138	18.5	17	29	32	1.3	1.3	2.5	0.45	1.32	0.73	0.053
4T-A4059†/A4138	19.5	19	29	32	0.8	1.3	2.5	0.45	1.32	0.73	0.049
4T-03062/03162	21.5	20	34	37.5	1.3	2	5.4	0.31	1.93	1.06	0.092
4T-11590/11520	24.5	22.5	34.5	39.5	1.5	1.5	1.2	0.70	0.85	0.47	0.103
4T-17580/17520	23	21	36.5	39	1.5	1.5	5.8	0.33	1.81	1.00	0.122
4T-05062/05185	23.5	21	40.5	42.5	1.5	1.3	4.2	0.36	1.68	0.92	0.131
4T-09062/09195	22	21.5	42	44.5	0.8	1.3	9.4	0.27	2.26	1.24	0.203
4T-05066/05185	24.5	22	40.5	42.5	1.5	1.3	4.2	0.36	1.68	0.92	0.127
4T-LM11749/LM11710	23	21.5	34	37	1.3	1.3	5.3	0.29	2.10	1.15	0.084
4T-A6075/A6157	24	23	34	37	1	1.3	1.5	0.53	1.14	0.63	0.065
4T-LM11949/LM11910	28	23.5	39.5	41.5	1.3	1.3	5.6	0.30	2.00	1.10	0.122
4T-05075/05185	25	23.5	40.5	42.5	1.3	1.3	4.2	0.36	1.68	0.92	0.121
4T-09067/09195	25.5	24	42	44.5	1.3	1.3	7.6	0.27	2.26	1.24	0.179
4T-09078/09195	25.5	24	42	44.5	1.3	1.3	9.4	0.27	2.26	1.24	0.188
4T-09067/09196	25.5	24	41.5	44.5	1.3	1.5	7.6	0.27	2.26	1.24	0.198
4T-21075/21212††	31.5	26	43	50	1.5	2.3	5.6	0.59	1.02	0.56	0.248
4T-1775/1729	27	25	49	51	1.5	1.3	6.5	0.31	1.95	1.07	0.272
4T-05079†/05185	26.5	24	40.5	42.5	1.5	1.3	4.2	0.36	1.68	0.92	0.117
4T-07079/07196	27.5	26	44.5	47	1.5	1	3.0	0.40	1.49	0.82	0.138
4T-09081/09195	27.5	25.5	42	44.5	1.5	1.3	9.4	0.27	2.26	1.24	0.179
4T-12580/12520	28.5	26	42.5	45.5	1.5	1.5	7.1	0.32	1.86	1.02	0.182
4T-M12649/M12610	29	25.5	44	46	1.3	1.3	6.4	0.28	2.16	1.19	0.169
4T-LM12749†/LM12711††	27.5	26	40	42.5	1.3	1.3	5.4	0.31	1.96	1.08	0.123
4T-07087/07196	28.5	27	44.5	47	1.3	1	3.0	0.40	1.49	0.82	0.13
4T-M12648/M12610	28.5	26.5	44	46	1.3	1.3	6.4	0.28	2.16	1.19	0.165
4T-1380/1328	29.5	27	45	48.5	1.5	1.5	7.4	0.29	2.05	1.13	0.2
4T-1380/1329††	29.5	27	46	49	1.5	1.5	7.4	0.29	2.05	1.13	0.215

Inch series

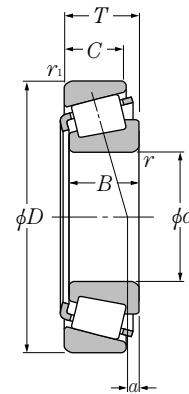

d 22.225 ~ 28.575mm

d	Boundary dimensions				dynamic kN	Basic load ratings		dynamic kgf	static kgf	Limiting speeds	
	D	T	B	C		static	dynamic			grease	oil
22.225	56.896	19.368	19.837	15.875	42.5	46.5	4 350	4 750	7 200	9 600	
	57.150	22.225	22.225	17.462	47.0	49.5	4 800	5 050	7 100	9 500	
22.606	47.000	15.500	15.500	12.000	27.5	32.5	2 800	3 300	8 200	11 000	
23.812	50.005	13.495	14.260	9.525	26.0	27.9	2 650	2 850	7 500	10 000	
	50.292	14.224	14.732	10.668	28.8	34.0	2 940	3 450	7 400	9 900	
	56.896	19.368	19.837	15.875	42.5	46.5	4 350	4 750	7 200	9 600	
24.981	50.005	13.495	14.260	9.525	26.0	27.9	2 650	2 850	7 500	10 000	
25.000	50.005	13.495	14.260	9.525	26.0	27.9	2 650	2 850	7 500	10 000	
25.159	50.005	13.495	14.260	9.525	26.0	27.9	2 650	2 850	7 500	10 000	
25.400	50.005	13.495	14.260	9.525	26.0	27.9	2 650	2 850	7 500	10 000	
	50.005	13.495	14.260	9.525	26.0	27.9	2 650	2 850	7 500	10 000	
	50.292	14.224	14.732	10.668	28.8	34.0	2 940	3 450	7 400	9 900	
	51.994	15.011	14.260	12.700	26.0	27.9	2 650	2 850	7 500	10 000	
	56.896	19.368	19.837	15.875	42.5	46.5	4 350	4 750	7 200	9 600	
	57.150	19.431	19.431	14.732	42.0	48.5	4 300	4 950	6 900	9 200	
	61.912	19.050	20.638	14.288	46.5	54.0	4 750	5 500	6 100	8 200	
	62.000	19.050	20.638	14.288	46.5	54.0	4 750	5 500	6 100	8 200	
	62.000	19.050	20.638	14.288	46.5	54.0	4 750	5 500	6 100	8 200	
	64.292	21.433	21.433	16.670	51.5	64.5	5 250	6 600	6 100	8 100	
65.088	22.225	21.463	15.875	47.0	50.5	4 800	5 150	5 700	7 600		
66.421	23.812	25.433	19.050	64.5	72.5	6 550	7 400	6 200	8 200		
26.157	62.000	19.050	20.638	14.288	46.5	54.0	4 750	5 500	6 100	8 200	
26.162	66.421	23.812	25.433	19.050	64.5	72.5	6 550	7 400	6 200	8 200	
26.988	50.292	14.224	14.732	10.668	28.8	34.0	2 940	3 450	7 400	9 900	
	60.325	19.842	17.462	15.875	39.5	45.5	4 050	4 650	6 700	8 900	
	62.000	19.050	20.638	14.288	46.5	54.0	4 750	5 500	6 100	8 200	
	66.421	23.812	25.433	19.050	64.5	72.5	6 550	7 400	6 200	8 200	
28.575	56.896	19.845	19.355	15.875	40.5	44.5	4 150	4 550	6 700	8 900	
	57.150	17.462	17.462	13.495	39.5	45.5	4 050	4 650	6 700	8 900	

Note: 1. Chamfer dimensions on the back face of the inner and outer rings of the bearing are larger than maximum values for installation dimensions r_{as} and r_{1as} .
 2. As for the maximum value for inner ring bore diameters of bearings whose bearing numbers are marked with "+" (inner ring), the precision class is an integer for class 4 and class 2 bearings only.

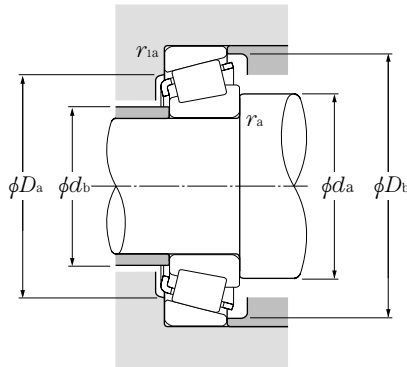

Equivalent radial load dynamic

$$P_r = XF_r + YF_a$$

$\frac{F_a}{F_r} \leq e$		$\frac{F_a}{F_r} > e$	
X	Y	X	Y
1	0	0.4	Y_2

static

$$P_{or} = 0.5F_r + Y_0F_a$$

When $P_{or} < F_r$ use $P_{or} = F_r$

For values of e , Y_2 and Y_0 see the table below.

Bearing numbers	Abutment and fillet dimensions						Load center mm	Constant e	Axial load factors		Mass kg (approx.)
	mm								a	e	
	d_a	d_b	D_a	D_b	r_{as} max	r_{1as} max					
4T-1755/1729	29	27.5	49	51	1.3	1.3	6.5	0.31	1.95	1.07	0.256
4T-1280/1220	29.5	29	49	52	0.8	1.5	7.1	0.35	1.73	0.95	0.286
4T-LM72849/LM72810	30	28	40.5	44	1.5	1	3.0	0.47	1.27	0.70	0.125
4T-07093/07196	30.5	28.5	44.5	47	1.5	1	3.0	0.40	1.49	0.82	0.123
4T-L44640/L44610	30.5	28.5	44.5	47	1.5	1.3	3.4	0.37	1.60	0.88	0.137
4T-1779/1729	29.5	28.5	49	51	0.8	1.3	6.5	0.31	1.95	1.07	0.247
4T-07098/07196	31	29	44.5	47	1.5	1	3.0	0.40	1.49	0.82	0.118
4T-07097/07196	31	29	44.5	47	1.5	1	3.0	0.40	1.49	0.82	0.118
4T-07096/07196	31.5	29.5	44.5	47	1.5	1	3.0	0.40	1.49	0.82	0.117
4T-07100/07196	30.5	29.5	44.5	47	1	1	3.0	0.40	1.49	0.82	0.117
4T-07100S/07196	31.5	29.5	44.5	47	1.5	1	3.0	0.40	1.49	0.82	0.116
4T-L44643/L44610	31.5	29.5	44.5	47	1.3	1.3	3.4	0.37	1.60	0.88	0.13
4T-07100/07204	30.5	29.5	45	48	1	1.3	3.0	0.40	1.49	0.82	0.144
4T-1780/1729	30.5	30	49	51	0.8	1.3	6.5	0.31	1.95	1.07	0.238
4T-M84548/M84510	36	33	48.5	54	1.5	1.5	3.4	0.55	1.10	0.60	0.241
4T-15101/15243	32.5	31.5	54	58	0.8	2	6.0	0.35	1.71	0.94	0.3
4T-15100/15245	38	31.5	55	58	3.5	1.3	6.0	0.35	1.71	0.94	0.299
4T-15102/15245	34	31.5	55	58	1.5	1.3	6.0	0.35	1.71	0.94	0.301
4T-M86643/M86610	38	36.5	54	61	1.5	1.5	3.3	0.55	1.10	0.60	0.371
4T-23100/23256	39	34.5	53	63	1.5	1.5	2.0	0.73	0.82	0.45	0.36
4T-2687/2631	33.5	31.5	58	60	1.3	1.3	9.3	0.25	2.36	1.30	0.442
4T-15103/15245	33	32.5	55	58	0.8	1.3	6.0	0.35	1.71	0.94	0.296
4T-2682/2631	34.5	32	58	60	1.5	1.3	9.3	0.25	2.36	1.30	0.436
4T-L44649†/L44610	37.5	31	44.5	47	3.5	1.3	3.4	0.37	1.60	0.88	0.12
4T-15580†/15523	38.5	32	51	54	3.5	1.5	5.0	0.35	1.73	0.95	0.26
4T-15106†/15245	33.5	33	55	58	0.8	1.3	6.0	0.35	1.71	0.94	0.291
4T-2688†/2631	35	33	58	60	1.5	1.3	9.3	0.25	2.36	1.30	0.429
4T-1985/1930	34	33.5	51	54	0.8	0.8	6.7	0.33	1.82	1.00	0.217
4T-15590/15520	39.5	33.5	51	53	3.5	1.5	5.0	0.35	1.73	0.95	0.196

Inch series J series

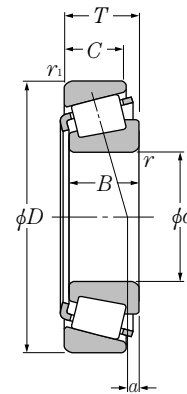

d 28.575 ~ 31.750mm

d	Boundary dimensions				dynamic kN	Basic load ratings			Limiting speeds	
	D	T	B	C		static	dynamic	static	grease	oil
	mm						kgf		min ⁻¹	
					C _r	C _{or}	C _r	C _{or}		
28.575	58.738	19.050	19.355	15.080	40.5	44.5	4 150	4 550	6 700	8 900
	60.325	19.842	17.462	15.875	39.5	45.5	4 050	4 650	6 700	8 900
	60.325	19.845	19.355	15.875	40.5	44.5	4 150	4 550	6 700	8 900
	62.000	19.050	20.638	14.288	46.5	54.0	4 750	5 500	6 100	8 200
	64.292	21.433	21.433	16.670	51.5	64.5	5 250	6 600	6 100	8 100
	66.421	23.812	25.433	19.050	64.5	72.5	6 550	7 400	6 200	8 200
	68.262	22.225	22.225	17.462	57.0	67.0	5 800	6 850	5 800	7 700
	68.262	22.225	23.812	17.462	57.5	65.5	5 850	6 700	5 700	7 700
	69.850	23.812	25.357	19.050	69.0	81.5	7 050	8 300	5 700	7 600
	72.626	24.608	24.257	17.462	58.0	55.5	5 900	5 700	5 800	7 700
73.025	22.225	22.225	17.462	56.5	68.0	5 750	6 900	5 300	7 000	
29.000	50.292	14.224	14.732	10.668	28.0	35.5	2 860	3 600	7 200	9 600
29.367	66.421	23.812	25.433	19.050	64.5	72.5	6 550	7 400	6 200	8 200
29.987	62.000	16.002	16.566	14.288	39.0	42.0	3 950	4 300	6 300	8 400
	62.000	19.050	20.638	14.288	46.5	54.0	4 750	5 500	6 100	8 200
30.000	69.012	19.845	19.583	15.875	48.5	58.0	4 900	5 900	5 600	7 400
	72.000	29.370	27.783	23.020	72.0	97.0	7 350	9 850	5 400	7 100
30.112	62.000	19.050	20.638	14.288	46.5	54.0	4 750	5 500	6 100	8 200
30.162	62.000	16.002	16.566	14.288	39.0	42.0	3 950	4 300	6 300	8 400
	64.292	21.433	21.433	16.670	51.5	64.5	5 250	6 600	6 100	8 100
	69.850	23.812	25.357	19.050	69.0	81.5	7 050	8 300	5 700	7 600
	72.626	30.162	29.997	23.812	84.5	98.0	8 600	9 950	5 500	7 300
30.213	62.000	19.050	20.638	14.288	46.5	54.0	4 750	5 500	6 100	8 200
	62.000	19.050	20.638	14.288	46.5	54.0	4 750	5 500	6 100	8 200
	62.000	19.050	20.638	14.288	46.5	54.0	4 750	5 500	6 100	8 200
30.226	69.012	19.845	19.583	15.875	48.5	58.0	4 900	5 900	5 600	7 400
	69.012	19.845	19.583	15.875	48.5	58.0	4 900	5 900	5 600	7 400
31.750	59.131	15.875	16.764	11.811	34.5	41.0	3 500	4 150	6 300	8 400
	62.000	18.161	19.050	14.288	46.5	54.0	4 750	5 500	6 100	8 200
	62.000	19.050	20.638	14.288	46.5	54.0	4 750	5 500	6 100	8 200

Note: 1. Chamfer dimensions on the back face of the inner and outer rings of the bearing are larger than maximum values for installation dimensions r_{as} and r_{1as} .
 2. As for the maximum value for inner ring bore diameters of bearings whose bearing numbers are marked with "+" (inner ring), the precision class is an integer for class 4 and class 2 bearings only.

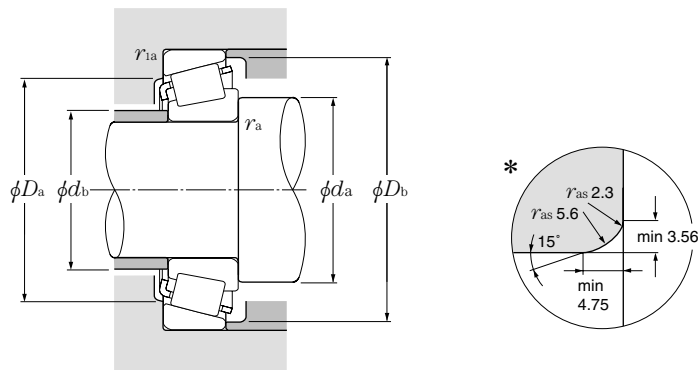

Equivalent radial load dynamic

$$P_r = XF_r + YF_a$$

$\frac{F_a}{F_r} \leq e$		$\frac{F_a}{F_r} > e$	
X	Y	X	Y
1	0	0.4	Y ₂

static

$$P_{or} = 0.5F_r + Y_0F_a$$

When $P_{or} < F_r$ use $P_{or} = F_r$

For values of e , Y_2 and Y_0 see the table below.

Bearing numbers	Abutment and fillet dimensions						Load center mm	Constant e	Axial load factors		Mass kg (approx.)
	d_a	d_b	D_a	D_b	r_{as} max	r_{1as} max			Y_2	Y_0	
4T-1985/1932	34	33.5	52	54	0.8	1.3	5.9	0.33	1.82	1.00	0.23
4T-15590/15523	39.5	33.5	51	54	3.5	1.5	5.0	0.35	1.73	0.95	0.25
4T-1985/1931	34	33.5	52	55	0.8	1.3	5.9	0.33	1.82	1.00	0.255
4T-15112/15245	40	34	55	58	3.5	1.3	6.0	0.35	1.71	0.94	0.277
4T-M86647/M86610	40	38	54	61	1.5	1.5	3.3	0.55	1.10	0.60	0.348
4T-2689/2631	36	34	58	60	1.3	1.3	9.3	0.25	2.36	1.30	0.416
4T-02474/02420	36.5	36	59	63	0.8	1.5	5.2	0.42	1.44	0.79	0.409
4T-2474/2420	36	35	60	63	0.8	1.5	6.5	0.34	1.77	0.97	0.41
4T-2578/2523	39	35	61	64	2.3	1.3	9.1	0.27	2.19	1.21	0.483
4T-41125/41286	48	36.5	61	68	4.8	1.5	3.7	0.60	1.00	0.55	0.477
4T-02872/02820	37.5	37	62	68	0.8	3.3	3.9	0.45	1.32	0.73	0.48
4T-L45449/L45410	39.5	33	44.5	48	3.5	1.3	3.5	0.37	1.62	0.89	0.113
4T-2690/2631	41	35	58	60	3.5	1.3	9.3	0.25	2.36	1.30	0.406
4T-17118†/17244	37	34.5	54	57	1.5	1.5	3.3	0.38	1.57	0.86	0.228
4T-15117†/15245	36.5	35	55	58	1.3	1.3	6.0	0.35	1.71	0.94	0.269
4T-14117A/14276	42.5	39.5	60	63	3.5	1.3	4.1	0.38	1.57	0.86	0.369
# 4T-JHM88540/JHM88513	44.5	42.5	58	69	1.3	3.3	6.0	0.55	1.10	0.60	0.619
4T-15116/15245	36	35.5	55	58	0.8	1.3	6.0	0.35	1.71	0.94	0.268
4T-17119/17244	37	34.5	54	57	1.5	1.5	3.3	0.38	1.57	0.86	0.226
4T-M86649/M86610	41	38	54	61	1.5	1.5	3.3	0.55	1.10	0.60	0.336
4T-2558/2523	40	36.5	61	64	2.3	1.3	9.1	0.27	2.19	1.21	0.468
4T-3187/3120	39	38.5	61	67	0.8	3.3	9.9	0.33	1.80	0.99	0.621
4T-15118/15245	41.5	35.5	55	58	3.5	1.3	6.0	0.35	1.71	0.94	0.265
4T-15119/15245	37.5	35.5	55	58	1.5	1.3	6.0	0.35	1.71	0.94	0.267
4T-15120/15245	36	35.5	55	58	0.8	1.3	6.0	0.35	1.71	0.94	0.267
4T-14116/14274	37	36.5	59	63	0.8	3.3	4.1	0.38	1.57	0.86	0.366
4T-14116/14276	37	36.5	60	63	0.8	1.3	4.1	0.38	1.57	0.86	0.37
4T-LM67048/LM67010	42.5	36	52	56	*	1.3	2.8	0.41	1.46	0.80	0.182
4T-15123/15245	42.5	36.5	55	58	*	1.3	5.1	0.35	1.71	0.94	0.244
4T-15125/15245	42.5	36.5	55	58	3.5	1.3	6.0	0.35	1.71	0.94	0.253

Note: 3. Bearing numbers marked " # " designate J-series bearings. The tolerances of these bearings is listed in Table 6.6 on page A-42.

4. Chamfer dimensions of bearings marked " * " are shown in drawings.

Inch series J series

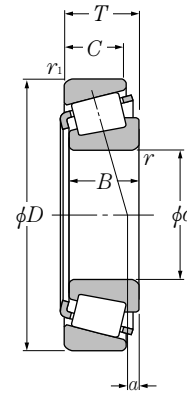

d 31.750 ~ 34.925mm

d	Boundary dimensions				dynamic kN	Basic load ratings			Limiting speeds	
	D	T	B	C		static	dynamic	static	grease	oil
	mm						kgf		min ⁻¹	
					C _r	C _{or}	C _r	C _{or}		
31.750	62.000	19.050	20.638	14.288	46.5	54.0	4 750	5 500	6 100	8 200
	66.421	25.400	25.357	20.638	69.0	81.5	7 050	8 300	5 700	7 600
	68.262	22.225	22.225	17.462	57.0	67.0	5 800	6 850	5 800	7 700
	68.262	22.225	22.225	17.462	57.0	67.0	5 800	6 850	5 800	7 700
	69.012	19.845	19.583	15.875	48.5	58.0	4 900	5 900	5 600	7 400
	69.012	19.845	19.583	15.875	48.5	58.0	4 900	5 900	5 600	7 400
	69.850	23.812	25.357	19.050	69.0	81.5	7 050	8 300	5 700	7 600
	69.850	23.812	25.357	19.050	69.0	81.5	7 050	8 300	5 700	7 600
	72.626	30.162	29.997	23.812	84.5	98.0	8 600	9 950	5 500	7 300
	72.626	30.162	29.997	23.812	84.5	98.0	8 600	9 950	5 500	7 300
	73.025	22.225	22.225	17.462	56.5	68.0	5 750	6 900	5 300	7 000
	73.025	22.225	23.812	17.462	62.5	75.5	6 400	7 700	5 200	7 000
	73.025	29.370	27.783	23.020	72.0	97.0	7 350	9 850	5 400	7 100
	73.812	29.370	27.783	23.020	72.0	97.0	7 350	9 850	5 400	7 100
	76.200	29.370	28.575	23.020	78.0	105	7 950	10 700	5 100	6 800
	79.375	29.370	29.771	23.812	93.0	114	9 450	11 600	4 900	6 600
33.338	68.262	22.225	22.225	17.462	56.5	71.0	5 750	7 250	5 700	7 500
	69.012	19.845	19.583	15.875	48.5	58.0	4 900	5 900	5 600	7 400
	69.850	23.812	25.357	19.050	69.0	81.5	7 050	8 300	5 700	7 600
	72.626	30.162	29.997	23.812	84.5	98.0	8 600	9 950	5 500	7 300
	73.025	29.370	27.783	23.020	72.0	97.0	7 350	9 850	5 400	7 100
	76.200	23.812	25.654	19.050	73.0	90.5	7 450	9 200	5 100	6 800
	76.200	29.370	28.575	23.020	78.0	105	7 950	10 700	5 100	6 800
	76.200	29.370	28.575	23.020	78.0	105	7 950	10 700	5 100	6 800
79.375	25.400	24.074	17.462	65.5	67.0	6 650	6 800	5 200	6 900	
34.925	65.088	18.034	18.288	13.970	46.5	56.0	4 750	5 700	5 700	7 600
	65.088	18.034	18.288	13.970	46.5	56.0	4 750	5 700	5 700	7 600
	69.012	19.845	19.583	15.875	48.5	58.0	4 900	5 900	5 600	7 400
	72.233	25.400	25.400	19.842	65.0	84.5	6 600	8 600	5 400	7 200
	72.238	20.638	20.638	15.875	48.0	58.5	4 900	5 950	5 300	7 000
	73.025	22.225	22.225	17.462	56.5	68.0	5 750	6 900	5 300	7 000
	73.025	22.225	22.225	17.462	56.5	68.0	5 750	6 900	5 300	7 000
	73.025	22.225	23.812	17.462	62.5	75.5	6 400	7 700	5 200	7 000
	73.025	23.812	24.608	19.050	71.0	85.0	7 200	8 700	5 300	7 100
	73.025	23.812	24.608	19.050	71.0	85.0	7 200	8 700	5 300	7 100
	73.025	23.812	25.654	19.050	73.0	90.5	7 450	9 200	5 100	6 800
	76.200	23.812	25.654	19.050	73.0	90.5	7 450	9 200	5 100	6 800

Note: 1. Chamfer dimensions on the back face of the inner and outer rings of the bearing are larger than maximum values for installation dimensions r_{as} and r_{1as} .
2. Chamfer dimensions of bearings marked " * " are shown in drawings.

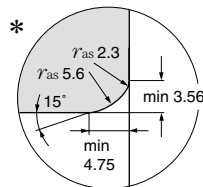
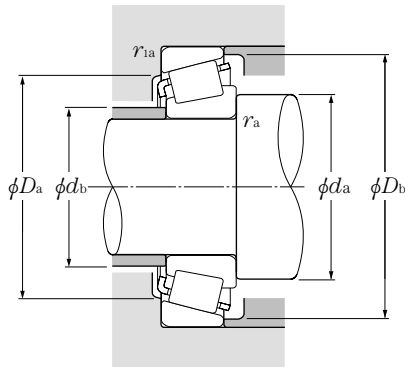

Equivalent radial load dynamic

$$P_r = XF_r + YF_a$$

$\frac{F_a}{F_r} \leq e$		$\frac{F_a}{F_r} > e$	
X	Y	X	Y
1	0	0.4	Y ₂

static

$$P_{or} = 0.5F_r + Y_0F_a$$

When $P_{or} < F_r$ use $P_{or} = F_r$

For values of e , Y_2 and Y_0 see the table below.

Bearing numbers	Abutment and fillet dimensions						Load center mm	Constant e	Axial load factors		Mass kg (approx.)
	d_a	d_b	D_a	D_b	r_{as} max	r_{1as} max			Y_2	Y_0	
4T-15126/15245	37	36.5	55	58	0.8	1.3	6.0	0.35	1.71	0.94	0.255
4T-2580/2520	38.5	37.5	57	62	0.8	3.3	9.1	0.27	2.19	1.21	0.409
4T-02475/02420	44.5	38.5	59	63	3.5	1.5	5.2	0.42	1.44	0.79	0.38
4T-02476/02420	39	38.5	59	63	0.8	1.5	5.2	0.42	1.44	0.79	0.383
4T-14124/14276	38.5	37.5	60	63	0.8	1.3	4.1	0.38	1.57	0.86	0.359
4T-14125A/14276	44	37.5	60	63	3.5	1.3	4.1	0.38	1.57	0.86	0.356
4T-2580/2523	38.5	37.5	61	64	0.8	1.3	9.1	0.27	2.19	1.21	0.454
4T-2582/2523	44	37.5	61	64	3.5	1.3	9.1	0.27	2.19	1.21	0.451
4T-3188/3120	40	39.5	61	67	0.8	3.3	9.9	0.33	1.80	0.99	0.603
4T-3193/3120	45.5	39.5	61	67	3.5	3.3	9.9	0.33	1.80	0.99	0.601
4T-02875/02820	45.5	39.5	62	68	3.5	3.3	3.9	0.45	1.32	0.73	0.451
4T-2879/2820	39.5	38.5	63	68	0.8	3.3	5.5	0.37	1.63	0.90	0.465
4T-HM88542/HM88510	45.5	42.5	59	70	1.3	3.3	6.0	0.55	1.10	0.60	0.622
4T-HM88542/HM88512	45.5	42.5	60	70	1.3	3.3	6.0	0.55	1.10	0.60	0.638
4T-HM89440/HM89410	45.5	44.5	62	73	0.8	3.3	5.8	0.55	1.10	0.60	0.686
4T-3476/3420	43	41	67	74	1.3	3.3	8.7	0.37	1.64	0.90	0.767
4T-M88048/M88010	42.5	41	58	65	0.8	1.5	2.9	0.55	1.10	0.60	0.378
4T-14130/14276	45	38.5	60	63	3.5	1.3	4.1	0.38	1.57	0.86	0.344
4T-2585/2523	45	39	61	64	3.5	1.3	9.1	0.27	2.19	1.21	0.435
4T-3196/3120	47	40.5	61	67	3.5	3.3	9.9	0.33	1.80	0.99	0.581
4T-HM88547/HM88510	45.5	42.5	59	70	0.8	3.3	6.0	0.55	1.10	0.60	0.604
4T-2785/2720	46	40	66	70	3.5	3.3	7.8	0.30	1.98	1.09	0.551
4T-HM89443/HM89410	46.5	44.5	62	73	0.8	3.3	5.8	0.55	1.10	0.60	0.668
4T-HM89444/HM89410	53	44.5	62	73	3.8	3.3	5.8	0.55	1.10	0.60	0.665
4T-43131/43312	51	42	67	74	3.5	1.5	1.4	0.67	0.90	0.49	0.568
4T-LM48548/LM48510	46	40	58	61	*	1.3	3.7	0.38	1.59	0.88	0.249
4T-LM48548A/LM48510	40.5	42	58	61	0.8	1.3	3.7	0.38	1.59	0.88	0.252
4T-14137A/14276	42	40	60	63	1.5	1.3	4.1	0.38	1.57	0.86	0.333
4T-HM88649/HM88610	48.5	42.5	60	69	2.3	2.3	4.6	0.55	1.10	0.60	0.489
4T-16137/16284	47	40.5	63	67	3.5	1.3	4.2	0.40	1.49	0.82	0.385
4T-02877/02820	48.5	42	62	68	3.5	3.3	3.9	0.45	1.32	0.73	0.422
4T-02878/02820	42.5	42	62	68	0.8	3.3	3.9	0.45	1.32	0.73	0.425
4T-2878/2820	42	41	63	68	0.8	3.3	5.5	0.37	1.63	0.90	0.434
4T-25877/25820	43	40.5	64	68	1.5	2.3	8.1	0.29	2.07	1.14	0.471
4T-25877/25821	43	40.5	65	68	1.5	0.8	8.1	0.29	2.07	1.14	0.474
4T-2793/2735X	42	41	66	69	0.8	0.8	7.8	0.30	1.98	1.09	0.485
4T-2793/2720	42	41	66	70	0.8	3.3	7.8	0.30	1.98	1.09	0.536

Inch series J series

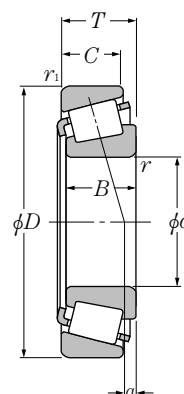

d 34.925 ~ 38.100mm

d	Boundary dimensions				dynamic kN	Basic load ratings			Limiting speeds	
	D	T	B	C		static	dynamic	static	grease	oil
	mm							kgf		min ⁻¹
	D	T	B	C	C _r	C _{or}	C _r	C _{or}	grease	oil
34.925	76.200	23.812	25.654	19.050	73.0	90.5	7 450	9 200	5 100	6 800
	76.200	29.370	28.575	23.020	78.0	105	7 950	10 700	5 100	6 800
	76.200	29.370	28.575	23.812	80.5	97.0	8 200	9 900	5 100	6 800
	76.200	29.370	28.575	23.812	80.5	97.0	8 200	9 900	5 100	6 800
	79.375	29.370	29.771	23.812	93.0	114	9 450	11 600	4 900	6 600
	80.167	29.370	30.391	23.812	95.0	112	9 700	11 400	4 800	6 400
85.725	30.162	30.162	23.812	23.812	105	132	10 700	13 400	4 500	6 000
34.976	69.012	19.845	19.583	15.875	48.5	58.0	4 900	5 900	5 600	7 400
34.988	59.974	15.875	16.764	11.938	35.5	47.5	3 600	4 850	6 100	8 100
	61.973	16.700	17.000	13.600	37.0	48.0	3 800	4 900	5 900	7 900
	61.973	18.000	17.000	15.000	37.0	48.0	3 800	4 900	5 900	7 900
35.000	70.000	24.000	23.500	19.000	62.0	78.0	6 350	7 950	5 500	7 300
	79.375	23.812	25.400	19.050	76.5	97.5	7 800	9 950	4 800	6 400
	80.000	21.000	22.403	17.826	68.0	75.0	6 950	7 650	4 700	6 300
35.717	72.233	25.400	25.400	19.842	65.0	84.5	6 600	8 600	5 400	7 200
	72.626	25.400	25.400	19.842	65.0	84.5	6 600	8 600	5 400	7 200
36.487	73.025	23.812	24.608	19.050	71.0	85.0	7 200	8 700	5 300	7 100
	76.200	23.812	25.654	19.050	73.0	90.5	7 450	9 200	5 100	6 800
36.512	76.200	29.370	28.575	23.020	78.0	105	7 950	10 700	5 100	6 800
	76.200	29.370	28.575	23.020	78.0	105	7 950	10 700	5 100	6 800
	76.200	29.370	28.575	23.812	80.5	97.0	8 200	9 900	5 100	6 800
	79.375	29.370	28.829	22.664	86.5	104	8 800	10 600	5 000	6 600
	79.375	29.370	29.771	23.812	93.0	114	9 450	11 600	4 900	6 600
	88.500	25.400	23.698	17.462	70.5	78.0	7 200	7 950	4 000	5 300
38.000	63.000	17.000	17.000	13.500	38.5	52.5	3 950	5 350	5 700	7 600
38.100	63.500	12.700	11.908	9.525	25.9	33.5	2 640	3 400	5 500	7 300
	65.088	18.034	18.288	13.970	43.5	57.0	4 400	5 800	5 500	7 400
	69.012	19.050	19.050	15.083	47.5	59.5	4 850	6 050	5 300	7 100
	69.012	19.050	19.050	15.083	47.5	59.5	4 850	6 050	5 300	7 100
	71.438	15.875	16.520	11.908	43.5	51.0	4 400	5 200	5 400	7 200
	72.000	19.000	20.638	14.237	48.0	58.5	4 900	5 950	5 300	7 000

Note: 1. Chamfer dimensions on the back face of the inner and outer rings of the bearing are larger than maximum values for installation dimensions r_{is} and r_{ios} .
 2. As for the maximum value for inner and outer ring diameters of bearings whose bearing numbers are marked with "+" (inner ring) and "++" (outer ring), the precision class is an integer for class 4 and class 2 bearings only.

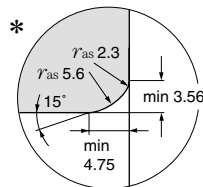
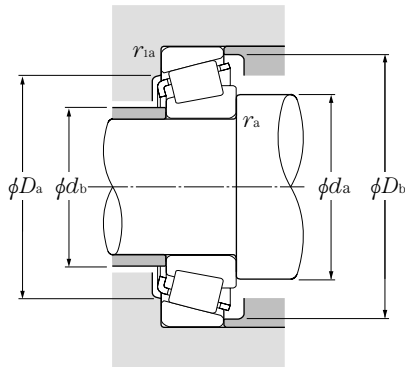

Equivalent radial load dynamic

$$P_r = XF_r + YF_a$$

$\frac{F_a}{F_r} \leq e$		$\frac{F_a}{F_r} > e$	
X	Y	X	Y
1	0	0.4	Y ₂

static

$$P_{or} = 0.5F_r + Y_0F_a$$

When $P_{or} < F_r$ use $P_{or} = F_r$

For values of e , Y_2 and Y_0 see the table below.

Bearing numbers	Abutment and fillet dimensions						Load center mm	Constant e	Axial load factors		Mass kg (approx.)
	d_a	d_b	D_a	D_b	r_{as} max	r_{1as} max			Y_2	Y_0	
4T-2793/2729	42	41	68	70	0.8	0.8	7.8	0.30	1.98	1.09	0.541
4T-HM89446/HM89410	53	44.5	62	73	3.5	3.3	5.8	0.55	1.10	0.60	0.646
4T-31593/31520	50	43.5	64	72	3.5	3.3	7.8	0.40	1.49	0.82	0.625
4T-31594/31520	46	43.5	64	72	1.5	3.3	7.8	0.40	1.49	0.82	0.627
4T-3478/3420	50	43.5	67	74	3.5	3.3	8.7	0.37	1.64	0.90	0.725
4T-3379/3320	48	41.5	70	75	3.5	3.3	11.2	0.27	2.20	1.21	0.732
4T-3872/3820	53	46	73	81	3.5	3.3	8.1	0.40	1.49	0.82	0.897
4T-14139/14276	41.5	40	60	63	1.3	1.3	4.1	0.38	1.57	0.86	0.333
4T-L68149†/L68111††	45.5	39	53	56	*	1.3	2.5	0.42	1.44	0.79	0.179
4T-LM78349A†/LM78310A††	42	39.5	54	59	1.5	1.5	2.4	0.44	1.35	0.74	0.209
4T-LM78349†/LM78310C††	46	40	56	59	*	1.5	2.4	0.44	1.35	0.74	0.218
# 4T-JS3549A/JS3510	47	42	60	67	2	1.5	3.6	0.55	1.10	0.60	0.42
4T-26883/26822	42.5	42	71	74	0.8	0.8	7.4	0.32	1.88	1.04	0.61
4T-339/332	42.5	41.5	73	75	0.8	1.3	6.6	0.27	2.20	1.21	0.534
4T-HM88648/HM88610	52	43	60	69	3.5	2.3	4.6	0.55	1.10	0.60	0.478
4T-HM88648/HM88611AS	52	43	59	69	3.5	3.3	3.0	0.55	1.10	0.60	0.482
4T-25880/25821	44	42	65	68	1.5	0.8	8.1	0.29	2.07	1.14	0.457
4T-2780/2720	44.5	42.5	66	70	1.5	3.3	7.8	0.30	1.98	1.09	0.518
4T-HM89448/HM89410	48.5	44.5	62	73	0.8	3.3	5.8	0.55	1.10	0.60	0.629
4T-HM89449/HM89411	54	44.5	65	73	3.5	0.8	5.8	0.55	1.10	0.60	0.631
4T-31597/31520	51	44.5	64	72	3.5	3.3	7.8	0.40	1.49	0.82	0.605
4T-HM89249/HM89210	55	44	66	75	3.5	3.3	5.8	0.55	1.10	0.60	0.686
4T-3479/3420	45.5	44.5	67	74	0.8	3.3	8.7	0.37	1.64	0.90	0.707
4T-44143/44348	54	50	75	84	2.3	1.5	-2.9	0.78	0.77	0.42	0.729
# 4T-JL69349/JL69310	49	42.5	56	60	*	1.3	2.3	0.42	1.44	0.79	0.198
4T-13889/13830	45	42.5	59	60	1.5	0.8	0.8	0.35	1.73	0.95	0.147
4T-LM29748/LM29710	49	42.5	59	62	*	1.3	4.3	0.33	1.80	0.99	0.233
4T-13685/13621	49.5	43	61	65	3.5	2.3	3.0	0.40	1.49	0.82	0.293
4T-13687/13621	46.5	43	61	65	2	2.3	3.0	0.40	1.49	0.82	0.296
4T-19150/19281	45	43	63	66	1.5	1	1.4	0.44	1.35	0.74	0.273
4T-16150/16282	49.5	43	63	67	3.5	1.5	4.2	0.40	1.49	0.82	0.331

Note: 3. Bearing numbers marked " # " designate **J-series** bearings. The tolerances of these bearings is listed in **Table 6.6** on **page A-42**.

4. Chamfer dimensions of bearings marked " * " are shown in drawings.

Inch series

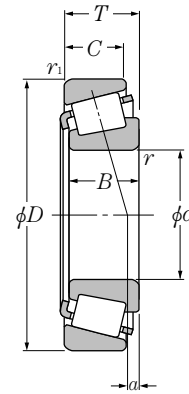

d 38.100 ~ 41.275mm

d	Boundary dimensions				dynamic kN	Basic load ratings			Limiting speeds	
	D	T	B	C		static	dynamic	static	grease	oil
	mm						kgf		min ⁻¹	
					C _r	C _{or}	C _r	C _{or}		
38.100	76.200	20.638	20.940	15.507	55.5	63.0	5 650	6 450	5 000	6 700
	76.200	23.812	25.654	19.050	73.0	90.5	7 450	9 200	5 100	6 800
	76.200	23.812	25.654	19.050	73.0	90.5	7 450	9 200	5 100	6 800
	79.375	23.812	25.400	19.050	76.5	97.5	7 800	9 950	4 800	6 400
	79.375	29.370	29.771	23.812	93.0	114	9 450	11 600	4 900	6 600
	80.000	21.006	20.940	15.875	55.5	63.0	5 650	6 450	5 000	6 700
	80.035	24.608	23.698	18.512	67.0	82.5	6 850	8 400	4 800	6 400
	82.550	29.370	28.575	23.020	87.0	117	8 850	11 900	4 700	6 200
	82.931	23.812	25.400	19.050	76.0	98.0	7 750	10 000	4 500	6 000
	85.725	30.162	30.162	23.812	105	132	10 700	13 400	4 500	6 000
	87.312	30.162	30.886	23.812	94.0	117	9 600	12 000	4 400	5 900
88.500	25.400	23.698	17.462	70.5	78.0	7 200	7 950	4 000	5 300	
88.500	26.988	29.083	22.225	95.5	107	9 750	10 900	4 600	6 100	
39.688	76.200	23.812	25.654	19.050	73.0	90.5	7 450	9 200	5 100	6 800
	77.534	29.370	30.391	23.812	95.0	112	9 700	11 400	4 800	6 400
	79.375	23.812	25.400	19.050	76.5	97.5	7 800	9 950	4 800	6 400
	80.035	29.370	30.391	23.812	95.0	112	9 700	11 400	4 800	6 400
	80.167	29.370	30.391	23.812	95.0	112	9 700	11 400	4 800	6 400
	88.500	25.400	23.698	17.462	70.5	78.0	7 200	7 950	4 000	5 300
40.000	76.200	20.638	20.940	15.507	55.5	63.0	5 650	6 450	5 000	6 700
	80.000	21.000	22.403	17.826	68.0	75.0	6 950	7 650	4 700	6 300
	85.000	20.638	21.692	17.462	69.5	79.5	7 100	8 100	4 400	5 800
	88.500	26.988	29.083	22.225	95.5	107	9 750	10 900	4 600	6 100
	107.950	36.512	36.957	28.575	141	177	14 400	18 100	3 600	4 800
40.483	82.550	29.370	28.575	23.020	87.0	117	8 850	11 900	4 700	6 200
40.988	67.975	17.500	18.000	13.500	46.0	62.5	4 700	6 400	5 300	7 000
41.275	73.025	16.667	17.462	12.700	46.0	55.5	4 700	5 700	5 000	6 600
	73.431	19.558	19.812	14.732	56.0	69.5	5 700	7 100	5 000	6 600
	73.431	21.430	19.812	16.604	56.0	69.5	5 700	7 100	5 000	6 600
	76.200	18.009	17.384	14.288	42.5	51.5	4 350	5 250	4 900	6 500
	76.200	22.225	23.020	17.462	65.0	80.5	6 600	8 200	4 900	6 500
	76.200	25.400	25.400	20.638	76.5	97.5	7 800	9 950	4 800	6 400
	79.375	23.812	25.400	19.050	76.5	97.5	7 800	9 950	4 800	6 400
	80.000	18.009	17.384	14.288	42.5	51.5	4 350	5 250	4 900	6 500

Note: 1. Chamfer dimensions on the back face of the inner and outer rings of the bearing are larger than maximum values for installation dimensions r_{is} and r_{ias} .
 2. As for the maximum value for inner and outer ring diameters of bearings whose bearing numbers are marked with "+" (inner ring) and "++" (outer ring), the precision class is an integer for class 4 and class 2 bearings only.

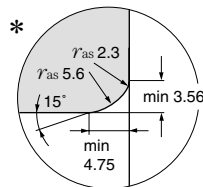
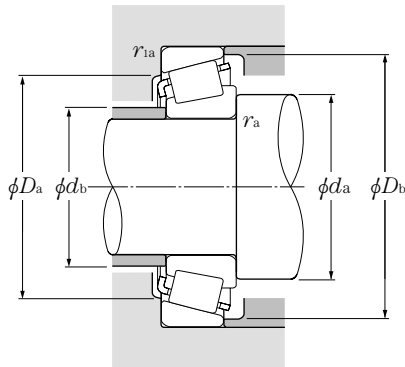

Equivalent radial load dynamic

$$P_r = XF_r + YF_a$$

$\frac{F_a}{F_r} \leq e$		$\frac{F_a}{F_r} > e$	
X	Y	X	Y
1	0	0.4	Y ₂

static

$$P_{or} = 0.5F_r + Y_0F_a$$

When $P_{or} < F_r$ use $P_{or} = F_r$

For values of e , Y_2 and Y_0 see the table below.

Bearing numbers	Abutment and fillet dimensions						Load center mm	Constant e	Axial load factors		Mass kg (approx.)
	d_a	d_b	D_a	D_b	r_{as} max	r_{1as} max			Y_2	Y_0	
4T-28150/28300	45.5	43.5	68	71	1.5	1.3	4.8	0.40	1.49	0.82	0.405
4T-2776/2720	52	43.5	66	70	4.3	3.3	7.8	0.30	1.98	1.09	0.495
4T-2788/2720	50	43.5	66	70	3.5	3.3	7.8	0.30	1.98	1.09	0.497
4T-26878/26822	45	44.5	71	74	0.8	0.8	7.4	0.32	1.88	1.04	0.574
4T-3490/3420	52	45.5	67	74	3.5	3.3	8.7	0.37	1.64	0.90	0.683
4T-28150/28315	45.5	43.5	69	73	1.5	1.5	4.8	0.40	1.49	0.82	0.467
4T-27880/27820	48	47	68	75	0.8	1.5	2.5	0.56	1.07	0.59	0.562
4T-HM801346/HM801310	51	49	68	78	0.8	3.3	4.7	0.55	1.10	0.60	0.767
4T-25572/25520	46	46	74	77	0.8	0.8	6.2	0.33	1.79	0.99	0.645
4T-3875/3820	49.5	48.5	73	81	0.8	3.3	8.1	0.40	1.49	0.82	0.857
4T-3580/3525	48	45.5	75	81	1.5	3.3	10.0	0.31	1.96	1.08	0.881
4T-44150/44348	55	51	75	84	2.3	1.5	-2.9 ¹⁾	0.78	0.77	0.42	0.711
4T-418/414	51	44.5	77	80	3.5	1.5	9.1	0.26	2.28	1.25	0.84
4T-2789/2720	52	45	66	70	3.5	3.3	7.8	0.30	1.98	1.09	0.477
4T-3382/3321	52	45.5	68	75	3.5	3.3	11.2	0.27	2.20	1.21	0.669
4T-26880/26822	48	45.5	71	74	1.5	0.8	7.4	0.32	1.88	1.04	0.554
4T-3382/3339	52	45.5	71	75	3.5	1.5	11.2	0.27	2.20	1.21	0.666
4T-3386/3320	46.5	45.5	70	75	0.8	3.3	11.2	0.27	2.20	1.21	0.668
4T-44158/44348	58	51	75	84	3.5	1.5	-2.9 ¹⁾	0.78	0.77	0.42	0.691
4T-28158/28300	47.5	45	68	71	1.5	1.3	4.8	0.40	1.49	0.82	0.386
4T-344/332	52	45.5	73	75	3.5	1.3	6.6	0.27	2.20	1.21	0.479
4T-350A/354A	47.5	46.5	77	80	0.8	1.3	5.1	0.31	1.96	1.08	0.562
4T-420/414	52	46	77	80	3.5	1.5	9.1	0.26	2.28	1.25	0.813
4T-543/532X	57	50	94	100	3.5	3.3	12.3	0.30	2.02	1.11	1.77
4T-HM801349/HM801310	58	49	68	78	3.5	3.3	4.7	0.55	1.10	0.60	0.731
4T-LM300849†/LM300811††	52	45	61	65	*	1.5	3.6	0.35	1.72	0.95	0.239
4T-18590/18520	53	46	66	69	3.5	1.5	2.9	0.35	1.71	0.94	0.281
4T-LM501349/LM501310	53	46.5	67	70	3.5	0.8	3.3	0.40	1.50	0.83	0.335
4T-LM501349/LM501314	53	46.5	66	70	3.5	0.8	3.3	0.40	1.50	0.83	0.355
4T-11162/11300	49	46.5	67	71	1.5	1.5	0.7	0.49	1.23	0.68	0.337
4T-24780/24720	54	47	68	72	3.5	0.8	4.5	0.39	1.53	0.84	0.432
4T-26882/26823	54	47	69	73	3.5	1.5	7.4	0.32	1.88	1.04	0.488
4T-26885/26822	48	47	71	74	0.8	0.8	7.4	0.32	1.88	1.04	0.535
4T-11162/11315	49	46.5	69	73	1.5	1.5	0.7	0.49	1.23	0.68	0.389

Note: 3. Chamfer dimensions of bearings marked " * " are shown in drawings.

1) " - " means that load center at outside on end of inner ring.

Inch series

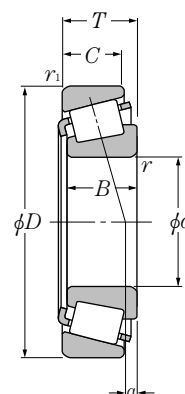

d 41.275 ~ 44.450mm

d	Boundary dimensions				dynamic kN	Basic load ratings		dynamic kgf	static kgf	Limiting speeds	
	D	T	B	C		static	C _{or}			grease	oil
41.275	80.000	21.000	22.403	17.826	68.0	75.0	6 950	7 650	4 700	6 300	
	80.000	23.812	25.400	19.050	76.5	97.5	7 800	9 950	4 800	6 400	
	82.550	26.543	25.654	20.193	80.5	104	8 200	10 600	4 600	6 100	
	85.725	30.162	30.162	23.812	105	132	10 700	13 400	4 500	6 000	
	87.312	30.162	30.886	23.812	94.0	117	9 600	12 000	4 400	5 900	
	88.900	30.162	29.370	23.020	93.5	125	9 550	12 700	4 300	5 800	
	90.488	39.688	40.386	33.338	136	175	13 900	17 900	4 300	5 800	
	92.075	26.195	23.812	16.670	72.5	81.5	7 400	8 300	3 800	5 000	
	93.662	31.750	31.750	26.195	104	131	10 600	13 400	4 100	5 500	
	95.250	30.162	29.370	23.020	109	147	11 100	15 000	4 000	5 300	
95.250	30.958	28.300	20.638	82.5	92.0	8 400	9 350	3 700	5 000		
95.250	30.958	28.575	22.225	96.0	116	9 800	11 800	3 700	4 900		
42.070	90.488	39.688	40.386	33.338	136	175	13 900	17 900	4 300	5 800	
42.862	82.550	26.195	26.988	20.638	75.5	97.0	7 700	9 900	4 600	6 100	
	82.931	23.812	25.400	19.050	76.0	98.0	7 750	10 000	4 500	6 000	
	87.312	30.162	30.886	23.812	94.0	117	9 600	12 000	4 400	5 900	
42.875	79.375	23.812	25.400	19.050	76.5	97.5	7 800	9 950	4 800	6 400	
	82.931	23.812	25.400	19.050	76.0	98.0	7 750	10 000	4 500	6 000	
44.450	76.992	17.462	17.145	11.908	44.0	54.0	4 450	5 550	4 700	6 300	
	79.375	17.462	17.462	13.495	45.5	56.0	4 600	5 700	4 600	6 200	
	82.931	23.812	25.400	19.050	76.0	98.0	7 750	10 000	4 500	6 000	
	82.931	23.812	25.400	19.050	76.0	98.0	7 750	10 000	4 500	6 000	
	84.138	30.162	30.886	23.812	94.0	117	9 600	12 000	4 400	5 900	
	85.000	20.638	21.692	17.462	69.5	79.5	7 100	8 100	4 400	5 800	
	87.312	30.162	30.886	23.812	94.0	117	9 600	12 000	4 400	5 900	
	88.900	30.162	29.370	23.020	93.5	125	9 550	12 700	4 300	5 800	
	93.264	30.162	30.302	23.812	102	134	10 400	13 700	4 000	5 300	
	93.662	31.750	31.750	26.195	103	131	10 600	13 400	4 100	5 500	
	95.250	27.783	28.575	22.225	107	139	10 900	14 200	3 900	5 200	
	95.250	27.783	29.900	22.225	108	129	11 000	13 200	4 200	5 600	
	95.250	30.162	29.370	23.020	109	147	11 100	15 000	4 000	5 300	
	95.250	30.958	28.300	20.638	82.5	92.0	8 400	9 350	3 700	5 000	
	95.250	30.958	28.575	22.225	96.0	116	9 800	11 800	3 700	4 900	
101.600	34.925	36.068	26.988	135	165	13 800	16 800	3 800	5 000		
104.775	30.162	29.317	24.605	115	148	11 700	15 000	3 500	4 700		

Note: 1. Chamfer dimensions on the back face of the inner and outer rings of the bearing are larger than maximum values for installation dimensions r_{as} and r_{1as} .

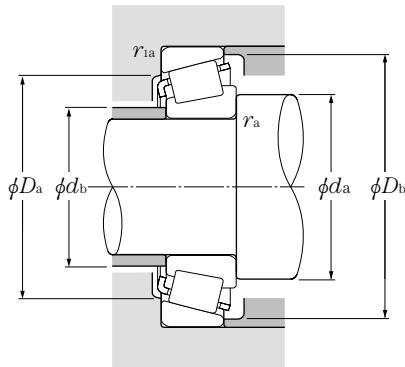

Equivalent radial load dynamic

$$P_r = XF_r + YF_a$$

$\frac{F_a}{F_r} \leq e$		$\frac{F_a}{F_r} > e$	
X	Y	X	Y
1	0	0.4	Y ₂

static

$$P_{or} = 0.5F_r + Y_0F_a$$

When $P_{or} < F_r$ use $P_{or} = F_r$

For values of e , Y_2 and Y_0 see the table below.

Bearing numbers	Abutment and fillet dimensions						Load center mm	Constant	Axial load factors		Mass kg
	mm								a	e	
	d_a	d_b	D_a	D_b	r_{as} max	r_{1as} max					(approx.)
4T-336/332	47	46	73	75	0.8	1.3	6.6	0.27	2.20	1.21	0.468
4T-26882/26824	54	47	70	74	3.5	1.3	7.4	0.32	1.88	1.04	0.542
4T-M802048/M802011	57	51	70	79	3.5	3.3	3.2	0.55	1.10	0.60	0.642
4T-3880/3820	52	50	73	81	0.8	3.3	8.1	0.40	1.49	0.82	0.81
4T-3576/3525	49	48	75	81	0.8	3.3	10.0	0.31	1.96	1.08	0.834
4T-HM803145/HM803110	54	53	74	85	0.8	3.3	4.6	0.55	1.10	0.60	0.901
4T-4388/4335	57	51	77	85	3.5	3.3	15.0	0.28	2.11	1.16	1.25
4T-M903345/M903310	60	54	78	88	3.5	1.5	-3.6 ¹⁾	0.83	0.72	0.40	0.758
4T-46162/46368	52	51	79	87	0.8	3.3	7.1	0.40	1.49	0.82	1.09
4T-HM804840/HM804810	61	54	81	91	3.5	3.3	3.7	0.55	1.10	0.60	1.08
4T-53162/53375	57	53	81	89	1.5	0.8	0.5	0.74	0.81	0.45	0.975
4T-HM903245/HM903210	63	54	81	91	3.5	0.8	-0.4 ¹⁾	0.74	0.81	0.45	1.05
4T-4395/4335	58	51	77	85	3.5	3.3	15.0	0.28	2.11	1.16	1.24
4T-22780/22720	56	50	71	77	3.5	3.3	6.4	0.40	1.49	0.82	0.617
4T-25578/25520	53	49.5	74	77	2.3	0.8	6.2	0.33	1.79	0.99	0.584
4T-3579/3525	56	49.5	75	81	3.5	3.3	10.0	0.31	1.96	1.08	0.805
4T-26884/26822	55	48.5	71	74	3.5	0.8	7.4	0.32	1.88	1.04	0.51
4T-25577/25520	55	49	74	77	3.5	0.8	6.2	0.33	1.79	0.99	0.581
4T-12175/12303	52	49.5	68	73	1.5	1.5	-0.2 ¹⁾	0.51	1.19	0.65	0.308
4T-18685/18620	54	49.5	71	74	2.8	1.5	2.2	0.37	1.60	0.88	0.345
4T-25580/25520	57	50	74	77	3.5	0.8	6.2	0.33	1.79	0.99	0.56
4T-25582/25520	60	50	74	77	5	0.8	6.2	0.33	1.79	0.99	0.556
4T-3578/3520	57	51	74	80	3.5	3.3	10.0	0.31	1.96	1.08	0.699
4T-355/354A	54	50	77	80	2.3	1.3	5.1	0.31	1.96	1.08	0.511
4T-3578/3525	57	51	75	81	3.5	3.3	10.0	0.31	1.96	1.08	0.779
4T-HM803149/HM803110	62	53	74	85	3.5	3.3	4.6	0.55	1.10	0.60	0.849
4T-3782/3720	58	52	82	88	3.5	3.3	8.3	0.34	1.77	0.97	0.961
4T-46175/46368	55	54	79	87	0.8	3.3	7.1	0.40	1.49	0.82	1.04
4T-33885/33821	53	53	85	90	0.8	2.3	8.0	0.33	1.82	1.00	0.987
4T-438/432	57	51	83	87	3.5	2.3	9.2	0.28	2.11	1.16	0.953
4T-HM804842/HM804810	57	57	81	91	0.8	3.3	3.7	0.55	1.10	0.60	1.04
4T-53177/53375	63	53	81	89	3.5	0.8	0.5	0.74	0.81	0.45	0.925
4T-HM903249/HM903210	65	54	81	91	3.5	0.8	-0.4 ¹⁾	0.74	0.81	0.45	1
4T-527/522	59	53	89	95	3.5	3.3	12.9	0.29	2.10	1.16	1.37
4T-460/453X	60	54	92	98	3.5	3.3	7.1	0.34	1.79	0.98	1.29

1) " - " means that load center at outside on end of inner ring.

Inch series

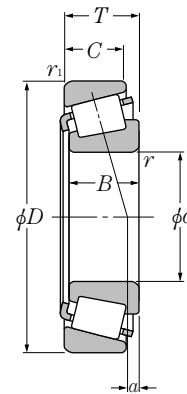

d 44.450 ~ 47.625mm

d	Boundary dimensions				dynamic kN	Basic load ratings			Limiting speeds	
	D	T	B	C		static	dynamic	static	grease	oil
	mm						kgf		min ⁻¹	
					C _r	C _{or}	C _r	C _{or}		
44.450	104.775	30.162	30.958	23.812	130	169	13 200	17 300	3 500	4 700
	104.775	36.512	36.512	28.575	138	189	14 000	19 300	3 600	4 800
	111.125	30.162	26.909	20.638	104	136	10 600	13 900	3 200	4 200
	111.125	30.162	26.909	20.638	104	136	10 600	13 900	3 200	4 200
	127.000	50.800	52.388	41.275	250	320	25 500	33 000	3 200	4 300
44.983	82.931	23.812	25.400	19.050	76.0	98.0	7 750	10 000	4 500	6 000
	93.264	30.162	30.302	23.812	102	134	10 400	13 700	4 000	5 300
45.000	85.000	20.638	21.692	17.462	69.5	79.5	7 100	8 100	4 400	5 800
	88.900	20.638	22.225	16.513	76.5	90.5	7 800	9 250	4 100	5 500
45.237	87.312	30.162	30.886	23.812	94.0	117	9 600	12 000	4 400	5 900
45.242	73.431	19.558	19.812	15.748	54.0	76.0	5 550	7 750	4 800	6 400
	77.788	19.842	19.842	15.080	57.5	73.5	5 850	7 500	4 600	6 200
45.618	82.550	23.812	25.400	19.050	76.0	98.0	7 750	10 000	4 500	6 000
	82.931	23.812	25.400	19.050	76.0	98.0	7 750	10 000	4 500	6 000
	83.058	23.876	25.400	19.114	76.0	98.0	7 750	10 000	4 500	6 000
	85.000	23.812	25.400	19.050	76.0	98.0	7 750	10 000	4 500	6 000
45.987	74.976	18.000	18.000	14.000	51.0	71.0	5 200	7 250	4 700	6 300
46.038	79.375	17.462	17.462	13.495	45.5	56.0	4 600	5 700	4 600	6 200
	82.931	23.812	25.400	19.050	76.0	98.0	7 750	10 000	4 500	6 000
	85.000	20.638	21.692	17.462	69.5	79.5	7 100	8 100	4 400	5 800
	85.000	25.400	25.608	20.638	79.0	104	8 050	10 600	4 400	5 800
	90.119	23.000	21.692	21.808	69.5	79.5	7 100	8 100	4 400	5 800
	93.264	30.162	30.302	23.812	102	134	10 400	13 700	4 000	5 300
	95.250	27.783	29.900	22.225	108	129	11 000	13 200	4 200	5 600
47.625	88.900	20.638	22.225	16.513	76.5	90.5	7 800	9 250	4 100	5 500
	88.900	25.400	25.400	19.050	82.0	101	8 350	10 300	4 200	5 600
	93.264	30.162	30.302	23.812	102	134	10 400	13 700	4 000	5 300
	95.250	30.162	29.370	23.020	109	147	11 100	15 000	4 000	5 300
	96.838	21.000	21.946	15.875	78.0	96.5	7 950	9 850	3 700	5 000
	101.600	34.925	36.068	26.988	135	165	13 800	16 800	3 800	5 000
	104.775	30.162	29.317	24.605	115	148	11 700	15 000	3 500	4 700

Note: 1. Chamfer dimensions on the back face of the inner and outer rings of the bearing are larger than maximum values for installation dimensions r_{is} and r_{ios} .
 2. As for the maximum value for inner and outer ring diameters of bearings whose bearing numbers are marked with "+" (inner ring) and "++" (outer ring), the precision class is an integer for class 4 and class 2 bearings only.

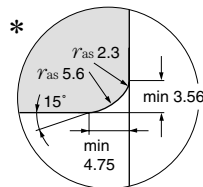
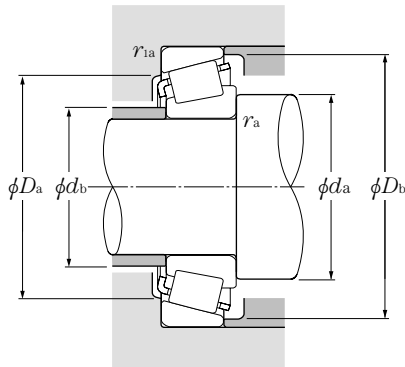

Equivalent radial load dynamic

$$P_r = XF_r + YF_a$$

$\frac{F_a}{F_r} \leq e$		$\frac{F_a}{F_r} > e$	
X	Y	X	Y
1	0	0.4	Y ₂

static

$$P_{or} = 0.5F_r + Y_0F_a$$

When $P_{or} < F_r$ use $P_{or} = F_r$

For values of e , Y_2 and Y_0 see the table below.

Bearing numbers	Abutment and fillet dimensions						Load center mm	Constant e	Axial load factors		Mass kg (approx.)
	d_a	d_b	D_a	D_b	r_{as} max	r_{1as} max			Y_2	Y_0	
4T-45280/45220	55	54	93	99	0.8	3.3	7.9	0.33	1.80	0.99	1.35
4T-HM807040/HM807010	66	59	89	100	3.5	3.3	7.4	0.49	1.23	0.68	1.62
4T-55175C/55437	70	64	92	105	3.5	3.3	-7.4 ¹⁾	0.88	0.68	0.37	1.45
4T-55176C/55437	65	65	92	105	0.8	3.3	-7.4 ¹⁾	0.88	0.68	0.37	1.09
4T-6277/6220	67	60	108	117	3.5	3.3	19.5	0.30	2.01	1.11	3.58
4T-25584/25520	53	51	74	77	1.5	0.8	6.2	0.33	1.79	0.99	0.555
4T-3776/3720	59	53	82	88	3.5	3.3	8.3	0.34	1.77	0.97	0.952
4T-358/354A	53	50	77	80	1.5	1.3	5.1	0.31	1.96	1.08	0.505
4T-367/362A	55	51	81	84	2	1.3	4.0	0.32	1.88	1.03	0.595
4T-3586/3525	58	52	75	81	3.5	3.3	10.0	0.31	1.96	1.08	0.765
4T-LM102949/LM102910	56	50	68	70	3.5	0.8	4.7	0.31	1.97	1.08	0.307
4T-LM603049/LM603011	57	50	71	74	3.5	0.8	2.2	0.43	1.41	0.77	0.372
4T-25590/25519	58	51	73	77	3.5	2	6.2	0.33	1.79	0.99	0.534
4T-25590/25520	58	51	74	77	3.5	0.8	6.2	0.33	1.79	0.99	0.543
4T-25590/25522	58	51	73	77	3.5	2	6.2	0.33	1.79	0.99	0.545
4T-25590/25526	58	51	74	78	3.5	2.3	6.2	0.33	1.79	0.99	0.581
4T-LM503349A†/LM503310††	57	51	67	71	*	1.5	1.9	0.40	1.49	0.82	0.296
4T-18690/18620	56	51	71	74	2.8	1.5	2.2	0.37	1.60	0.88	0.329
4T-25592/25520	58	52	74	77	3.5	0.8	6.2	0.33	1.79	0.99	0.538
4T-359A/354A	57	51	77	80	3.5	1.3	5.1	0.31	1.96	1.08	0.489
4T-2984/2924	58	52	76	80	3.5	1.3	6.4	0.35	1.73	0.95	0.615
4T-359S/352	55	51	78	82	2.3	2.3	5.1	0.31	1.96	1.08	0.651
4T-3777/3720	60	53	82	88	3.5	3.3	8.3	0.34	1.77	0.97	0.934
4T-436/432	59	52	83	87	3.5	2.3	9.2	0.28	2.11	1.16	0.927
4T-369A/362A	60	53	81	84	3.5	1.3	4.0	0.32	1.88	1.03	0.559
4T-M804048/M804010	57	56	77	85	0.8	3.3	1.7	0.55	1.10	0.60	0.662
4T-3778/3720	67	55	82	88	6.4	3.3	8.3	0.34	1.77	0.97	0.898
4T-HM804846/HM804810	66	57	81	91	3.5	3.3	3.7	0.55	1.10	0.60	0.978
4T-386A/382A	56	55	89	92	0.8	0.8	3.1	0.35	1.69	0.93	0.72
4T-528/522	62	55	89	95	3.5	3.3	12.9	0.29	2.10	1.16	1.3
4T-463/453X	65	56	92	98	4.8	3.3	7.1	0.34	1.79	0.98	1.24

Note: 3. Chamfer dimensions of bearings marked " * " are shown in drawings.

1) " - " means that load center at outside on end of inner ring.

Inch series J series

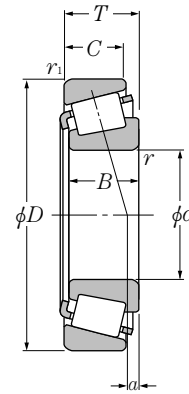

d 47.625 ~ 50.800mm

d	Boundary dimensions				dynamic kN	Basic load ratings			Limiting speeds	
	D	T	B	C		static	dynamic	static	grease	oil
	mm						kgf		min ⁻¹	
					C _r	C _{or}	C _r	C _{or}		
47.625	104.775	30.162	30.958	23.812	130	169	13 200	17 300	3 500	4 700
	111.125	30.162	26.909	20.638	104	136	10 600	13 900	3 200	4 200
	123.825	36.512	32.791	25.400	154	188	15 700	19 200	2 900	3 900
48.412	95.250	30.162	29.370	23.020	109	147	11 100	15 000	4 000	5 300
	95.250	30.162	29.370	23.020	109	147	11 100	15 000	4 000	5 300
49.212	93.264	30.162	30.302	23.812	102	134	10 400	13 700	4 000	5 300
	103.188	43.658	44.475	36.512	174	232	17 700	23 600	3 800	5 000
	104.775	36.512	36.512	28.575	138	189	14 000	19 300	3 600	4 800
	114.300	44.450	44.450	34.925	186	225	19 000	23 000	3 600	4 800
49.987	114.300	44.450	44.450	36.068	203	261	20 700	26 600	3 500	4 700
	82.550	21.590	22.225	16.510	69.5	94.0	7 100	9 600	4 300	5 700
	92.075	24.608	25.400	19.845	83.5	116	8 550	11 800	4 000	5 300
50.000	114.300	44.450	44.450	36.068	203	261	20 700	26 600	3 500	4 700
	82.000	21.500	21.500	17.000	69.5	94.0	7 100	9 600	4 300	5 700
	84.000	22.000	22.000	17.500	69.5	94.5	7 100	9 600	4 300	5 700
	88.900	20.638	22.225	16.513	76.5	90.5	7 800	9 250	4 100	5 500
	88.900	20.638	22.225	16.513	76.5	90.5	7 800	9 250	4 100	5 500
	90.000	28.000	28.000	23.000	106	141	10 800	14 400	4 100	5 400
50.800	105.000	37.000	36.000	29.000	138	189	14 000	19 300	3 600	4 800
	110.000	22.000	21.996	18.824	89.5	120	9 150	12 300	3 200	4 300
	82.550	21.590	22.225	16.510	69.5	94.0	7 100	9 600	4 300	5 700
	85.000	17.462	17.462	13.495	49.5	65.0	5 050	6 600	4 200	5 600
	88.900	17.462	17.462	13.495	49.5	65.0	5 050	6 600	4 200	5 600
	88.900	20.638	22.225	16.513	76.5	90.5	7 800	9 250	4 100	5 500
	88.900	20.638	22.225	16.513	76.5	90.5	7 800	9 250	4 100	5 500
	90.000	20.000	22.225	15.875	76.5	90.5	7 800	9 250	4 100	5 500
	92.075	24.608	25.400	19.845	83.5	116	8 550	11 800	4 000	5 300
	93.264	30.162	30.302	23.812	102	134	10 400	13 700	4 000	5 300
	93.264	30.162	30.302	23.812	102	134	10 400	13 700	4 000	5 300
	95.250	27.783	28.575	22.225	107	139	10 900	14 200	3 900	5 200
	95.250	30.162	30.302	23.812	102	134	10 400	13 700	4 000	5 300
	96.838	21.000	21.946	15.875	78.0	96.5	7 950	9 850	3 700	5 000
97.630	24.608	24.608	19.446	88.5	128	9 000	13 000	3 700	4 900	
98.425	30.162	30.302	23.812	102	134	10 400	13 700	4 000	5 300	

Note: 1. Chamfer dimensions on the back face of the inner and outer rings of the bearing are larger than maximum values for installation dimensions r_{as} and r_{1as} .
 2. As for the maximum value for inner ring bore diameters of bearings whose bearing numbers are marked with "+" (inner ring), the precision class is an integer for class 4 and class 2 bearings only.

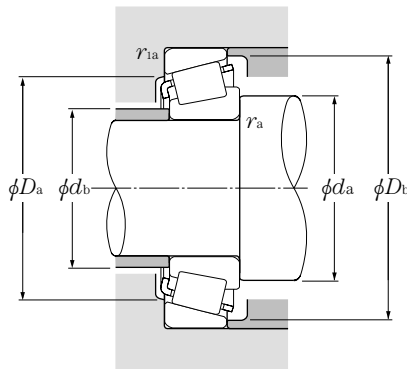

Equivalent radial load dynamic

$$P_r = XF_r + YF_a$$

$\frac{F_a}{F_r} \leq e$		$\frac{F_a}{F_r} > e$	
X	Y	X	Y
1	0	0.4	Y_2

static

$$P_{or} = 0.5F_r + Y_0F_a$$

When $P_{or} < F_r$ use $P_{or} = F_r$

For values of e , Y_2 and Y_0 see the table below.

Bearing numbers	Abutment and fillet dimensions						Load center mm	Constant e	Axial load factors		Mass kg (approx.)
	mm								a	e	
	d_a	d_b	D_a	D_b	r_{as} max	r_{1as} max					
4T-45282/45220	63	57	93	99	3.5	3.3	7.9	0.33	1.80	0.99	1.29
4T-55187C/55437	69	62	92	105	3.5	3.3	-7.4 ¹⁾	0.88	0.68	0.37	1.4
4T-72188C/72487	69	67	102	116	0.8	3.3	-1.5 ¹⁾	0.74	0.81	0.45	2.16
4T-HM804848/HM804810	63	57	81	91	2.3	3.3	3.7	0.55	1.10	0.60	0.967
4T-HM804849/HM804810	66	57	81	91	3.5	3.3	3.7	0.55	1.10	0.60	0.964
4T-3781/3720	62	56	82	88	3.5	3.3	8.3	0.34	1.77	0.97	0.877
4T-5395/5335	66	60	89	97	3.5	3.3	16.1	0.30	2.02	1.11	1.75
4T-HM807044/HM807010	69	63	89	100	3.5	3.3	7.4	0.49	1.23	0.68	1.52
4T-65390/65320	70	60	97	107	3.5	3.3	12.5	0.43	1.39	0.77	2.23
4T-HH506348/HH506310	71	61	97	107	3.5	3.3	13.3	0.40	1.49	0.82	2.33
4T-LM104947A†/LM104911	55	55	75	78	0.5	1.3	5.8	0.31	1.97	1.08	0.434
4T-28579†/28521	60	56	83	87	2.3	0.8	4.6	0.38	1.59	0.87	0.718
4T-HH506349†/HH506310	72	61	97	107	3.5	3.3	13.3	0.40	1.49	0.82	2.27
# 4T-JLM104948/JLM104910	60	55	76	78	3	0.5	5.4	0.31	1.97	1.08	0.42
# 4T-JLM704649/JLM704610	62	56	76	80	3.5	1.5	2.3	0.44	1.37	0.75	0.466
4T-365/362A	58	55	81	84	2	1.3	4.0	0.32	1.88	1.03	0.53
4T-366/362A	59	55	81	84	2.3	1.3	4.0	0.32	1.88	1.03	0.529
# 4T-JM205149/JM205110	62	57	80	85	3	2.5	7.4	0.33	1.82	1.00	0.752
# 4T-JHM807045/JHM807012	69	63	90	100	3	2.5	7.5	0.49	1.23	0.68	1.52
4T-396/394A	61	60	101	104	0.8	1.3	0.7	0.40	1.49	0.82	1.06
4T-LM104949/LM104911	62	55	75	78	3.5	1.3	5.8	0.31	1.97	1.08	0.419
4T-18790/18720	62	56	77	80	3.5	1.5	0.8	0.41	1.48	0.81	0.374
4T-18790/18724	62	56	78	82	3.5	1.3	0.8	0.41	1.48	0.81	0.431
4T-368/362A	58	56	81	84	1.5	1.3	4.0	0.32	1.88	1.03	0.519
4T-370A/362A	65	56	81	84	5	1.3	4.0	0.32	1.88	1.03	0.511
4T-368A/362	62	56	81	84	3.5	2	4.0	0.32	1.88	1.03	0.525
4T-28580/28521	63	57	83	87	3.5	0.8	4.6	0.38	1.59	0.87	0.703
4T-3775/3720	58	58	82	88	0.8	3.3	8.3	0.34	1.77	0.97	0.852
4T-3780/3720	64	58	82	88	3.5	3.3	8.3	0.34	1.77	0.97	0.848
4T-33889/33821	64	58	85	90	3.5	2.3	8.0	0.33	1.82	1.00	0.876
4T-3780/3726	64	58	83	89	3.5	3.3	8.3	0.34	1.77	0.97	0.903
4T-385A/382A	61	60	89	92	2.3	0.8	3.1	0.35	1.69	0.93	0.676
4T-28678/28622	65	58	88	92	3.5	0.8	3.3	0.40	1.49	0.82	0.852
4T-3780/3732	64	58	84	90	3.5	3.3	8.3	0.34	1.77	0.97	0.993

Note: 3. Bearing numbers marked " # " designate J-series bearings. The tolerances of these bearings is listed in Table 6.6 on page A-42.

1) " - " means that load center at outside on end of inner ring.

Inch series J series

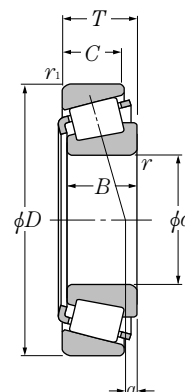

d 50.800 ~ 55.000mm

d	Boundary dimensions				dynamic kN	Basic load ratings			Limiting speeds	
	D	T	B	C		static	dynamic	static	grease	oil
	mm						kgf		min ⁻¹	
					C _r	C _{or}	C _r	C _{or}		
50.800	101.600	31.750	31.750	25.400	110	136	11 200	13 900	3 700	5 000
	101.600	34.925	36.068	26.988	135	165	13 800	16 800	3 800	5 000
	104.775	30.162	29.317	24.605	115	148	11 700	15 000	3 500	4 700
	104.775	30.162	30.958	23.812	130	169	13 200	17 300	3 500	4 700
	104.775	36.512	36.512	28.575	138	189	14 000	19 300	3 600	4 800
	104.775	36.512	36.512	28.575	143	178	14 500	18 100	3 700	4 900
	107.950	36.512	36.957	28.575	141	177	14 400	18 100	3 600	4 800
	111.125	30.162	28.575	20.638	104	136	10 600	13 900	3 200	4 200
	112.712	30.162	26.909	20.638	104	136	10 600	13 900	3 200	4 200
	112.712	30.162	30.048	23.812	119	174	12 200	17 800	3 200	4 300
	112.712	30.162	30.162	23.812	138	195	14 100	19 800	3 200	4 200
	117.475	33.338	31.750	23.812	130	153	13 200	15 600	3 300	4 400
	120.650	41.275	41.275	31.750	172	213	17 500	21 700	3 300	4 400
	123.825	36.512	32.791	25.400	154	188	15 700	19 200	2 900	3 900
123.825	38.100	36.678	30.162	158	216	16 100	22 000	3 000	4 100	
51.592	88.900	20.638	22.225	16.513	76.5	90.5	7 800	9 250	4 100	5 500
52.388	92.075	24.608	25.400	19.845	83.5	116	8 550	11 800	4 000	5 300
	93.264	30.162	30.302	23.812	102	134	10 400	13 700	4 000	5 300
	95.250	27.783	28.575	22.225	107	139	10 900	14 200	3 900	5 200
53.975	88.900	19.050	19.050	13.492	61.0	82.5	6 200	8 450	4 000	5 300
	95.250	27.783	28.575	22.225	107	139	10 900	14 200	3 900	5 200
	96.838	21.000	21.946	15.875	78.0	96.5	7 950	9 850	3 700	5 000
	104.775	30.162	30.958	23.812	130	169	13 200	17 300	3 500	4 700
	104.775	36.512	36.512	28.575	138	189	14 000	19 300	3 600	4 800
	107.950	36.512	36.957	28.575	141	177	14 400	18 100	3 600	4 800
	120.650	41.275	41.275	31.750	172	213	17 500	21 700	3 300	4 400
	122.238	33.338	31.750	23.812	134	163	13 700	16 600	3 100	4 200
	122.238	43.658	43.764	36.512	194	283	19 700	28 900	3 100	4 100
	123.825	36.512	32.791	25.400	154	188	15 700	19 200	2 900	3 900
	123.825	38.100	36.678	30.162	158	216	16 100	22 000	3 000	4 100
130.175	36.512	33.338	23.812	156	186	15 900	19 000	2 700	3 600	
140.030	36.512	33.236	23.520	171	212	17 400	21 600	2 600	3 400	
54.488	104.775	36.512	36.512	28.575	138	189	14 000	19 300	3 600	4 800
55.000	90.000	23.000	23.000	18.500	77.5	109	7 900	11 100	3 900	5 300

Note: 1. With regard to the chamfer dimensions on the back face of the inner and outer rings, installation dimensions r_{1is} and r_{1os} are larger than the maximum value.
2. Bearing numbers marked "# " designate J-series bearings. The accuracy of these bearings is listed in Table 6.6 on page A-42.

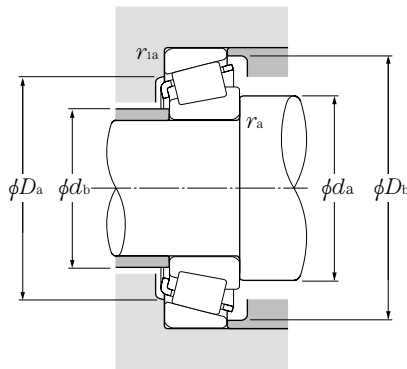

Equivalent radial load dynamic

$$P_r = XF_r + YF_a$$

$\frac{F_a}{F_r} \leq e$		$\frac{F_a}{F_r} > e$	
X	Y	X	Y
1	0	0.4	Y_2

static

$$P_{or} = 0.5F_r + Y_0F_a$$

When $P_{or} < F_r$ use $P_{or} = F_r$

For values of e , Y_2 and Y_0 see the table below.

Bearing numbers	Abutment and fillet dimensions						Load center mm	Constant e	Axial load factors		Mass kg (approx.)
	d_a	d_b	D_a	D_b	r_{as} max	r_{1as} max			Y_2	Y_0	
4T-49585/49520	66	59	88	96	3.5	3.3	7.1	0.40	1.50	0.82	1.13
4T-529/522	59	58	89	95	0.8	3.3	12.9	0.29	2.10	1.16	1.24
4T-455/453X	60	59	92	98	0.8	3.3	7.1	0.34	1.79	0.98	1.19
4T-45284/45220	71	59	93	99	6.4	3.3	7.9	0.33	1.80	0.99	1.22
4T-HM807046/HM807010	70	63	89	100	3.5	3.3	7.4	0.49	1.23	0.68	1.49
4T-59200/59412	68	61	92	99	3.5	3.3	9.6	0.40	1.49	0.82	1.44
4T-537/532X	65	59	94	100	3.5	3.3	12.3	0.30	2.02	1.11	1.55
4T-HM907643/HM907614	74	65	91	105	3.5	3.3	-7.2 ¹⁾	0.88	0.68	0.37	1.36
4T-55200C/55443	71	65	92	106	3.5	3.3	-7.4 ¹⁾	0.88	0.68	0.37	1.34
4T-3975/3920	68	61	99	106	3.5	3.3	4.5	0.40	1.49	0.82	1.53
4T-39575/39520	68	61	101	107	3.5	3.3	6.6	0.34	1.77	0.97	1.54
4T-66200/66462	71	65	100	111	3.5	3.3	0.4	0.63	0.96	0.53	1.67
4T-619/612	67	61	105	110	3.5	3.3	14.4	0.31	1.91	1.05	2.3
4T-72200C/72487	77	67	102	116	3.5	3.3	-1.5 ¹⁾	0.74	0.81	0.45	2.1
4T-555/552A	66	62	109	116	2.3	3.3	9.4	0.35	1.73	0.95	2.34
4T-368S/362A	59	56	81	84	2	1.3	4.0	0.32	1.88	1.03	0.507
4T-28584/28521	65	58	83	87	3.5	0.8	4.6	0.38	1.59	0.87	0.677
4T-3767/3720	63	59	82	88	2.3	3.3	8.3	0.34	1.77	0.97	0.819
4T-33890/33821	61	59	85	90	1.5	2.3	8.0	0.33	1.82	1.00	0.851
4T-LM806649/LM806610	63	60	80	85	2.3	2	-2.2 ¹⁾	0.55	1.10	0.60	0.437
4T-33895/33822	63	60	86	90	1.5	0.8	8.0	0.33	1.82	1.00	0.824
4T-389A/382A	61	60	89	92	0.8	0.8	3.1	0.35	1.69	0.93	0.633
4T-45287/45220	62	62	93	99	0.8	3.3	7.9	0.33	1.80	0.99	1.17
4T-HM807049/HM807010	73	63	89	100	3.5	3.3	7.4	0.49	1.23	0.68	1.41
4T-539/532X	68	61	94	100	3.5	3.3	12.3	0.30	2.02	1.11	1.47
4T-621/612	70	63	105	110	3.5	3.3	14.4	0.31	1.91	1.05	2.21
4T-66584/66520	75	68	105	116	3.5	3.3	-1.8 ¹⁾	0.67	0.90	0.50	1.79
4T-5578/5535	73	67	106	116	3.5	3.3	13.3	0.36	1.67	0.92	2.64
4T-72212C/72487	79	67	102	116	3.5	3.3	-1.5 ¹⁾	0.74	0.81	0.45	2.03
4T-557S/552A	71	65	109	116	3.5	3.3	9.4	0.35	1.73	0.95	2.26
4T-HM911242/HM911210	79	74	109	124	3.5	3.3	-5.2 ¹⁾	0.82	0.73	0.40	2.27
4T-78214C/78551	79	77	117	132	0.8	2.3	-8.5 ¹⁾	0.87	0.69	0.38	2.77
4T-HM807048/HM807010	73	63	89	100	3.5	3.3	7.4	0.49	1.23	0.68	1.40
# 4T-JLM506849/JLM506810	63	61	82	86	1.5	0.5	2.8	0.40	1.49	0.82	0.558

1) " - " means that load center at outside on end of inner ring.

Inch series J series

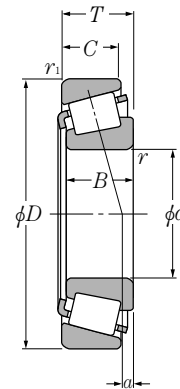

d 55.000 ~ 60.000mm

d	Boundary dimensions				dynamic kN	Basic load ratings			Limiting speeds	
	D	T	B	C		static	dynamic	static	grease	oil
	mm						kgf		min ⁻¹	
					C _r	C _{or}	C _r	C _{or}		
55.000	95.000	29.000	29.000	23.500	107	144	10 900	14 700	3 800	5 100
	96.838	21.000	21.946	15.875	78.0	96.5	7 950	9 850	3 700	5 000
	110.000	39.000	39.000	32.000	173	219	17 600	22 400	3 500	4 600
55.562	97.630	24.608	24.608	19.446	88.5	128	9 000	13 000	3 700	4 900
	123.825	36.512	32.791	25.400	154	188	15 700	19 200	2 900	3 900
	127.000	36.512	36.512	26.988	163	228	16 600	23 300	2 900	3 800
55.575	96.838	21.000	21.946	15.875	78	96.5	7 950	9 850	3 700	5 000
57.150	96.838	21.000	21.946	15.875	78	96.5	7 950	9 850	3 700	5 000
	96.838	21.000	21.946	15.875	78	96.5	7 950	9 850	3 700	5 000
	96.838	21.000	21.946	15.875	78	96.5	7 950	9 850	3 700	5 000
	96.838	21.000	21.946	15.875	78	96.5	7 950	9 850	3 700	5 000
	97.630	24.608	24.608	19.446	88.5	128	9 000	13 000	3 700	4 900
	104.775	30.162	29.317	24.605	115	148	11 700	15 000	3 500	4 700
	104.775	30.162	29.317	24.605	115	148	11 700	15 000	3 500	4 700
	104.775	30.162	30.958	23.812	130	169	13 200	17 300	3 500	4 700
	107.950	27.783	29.317	22.225	115	148	11 700	15 000	3 500	4 700
	110.000	22.000	21.996	18.824	89.5	120	9 150	12 300	3 200	4 300
	110.000	27.795	29.317	27.000	115	148	11 700	15 000	3 500	4 700
	112.712	30.162	30.048	23.812	119	174	12 200	17 800	3 200	4 300
	112.712	30.162	30.162	23.812	138	195	14 100	19 800	3 200	4 200
	112.712	30.162	30.162	23.812	138	195	14 100	19 800	3 200	4 200
	117.475	30.162	30.162	23.812	117	175	11 900	17 900	3 000	4 000
	117.475	33.338	31.750	23.812	130	153	13 200	15 600	3 300	4 400
	120.650	41.275	41.275	31.750	172	213	17 500	21 700	3 300	4 400
123.825	36.512	32.791	25.400	154	188	15 700	19 200	2 900	3 900	
123.825	38.100	36.678	30.162	158	216	16 100	22 000	3 000	4 100	
140.030	36.512	33.236	23.520	171	212	17 400	21 600	2 600	3 400	
57.531	96.838	21.000	21.946	15.875	78.0	96.5	7 950	9 850	3 700	5 000
59.972	122.238	33.338	31.750	23.812	134	163	13 700	16 600	3 100	4 200
59.987	146.050	41.275	39.688	25.400	199	234	20 300	23 900	2 400	3 200
60.000	95.000	24.000	24.000	19.000	83.0	122	8 500	12 400	3 700	4 900
	107.950	25.400	25.400	19.050	91.5	140	9 350	14 200	3 200	4 300

Note: 1. Chamfer dimensions on the back face of the inner and outer rings of the bearing are larger than maximum values for installation dimensions r_{1as} and r_{1is} .
 2. As for the maximum value for inner ring bore diameters of bearings whose bearing numbers are marked with "+" (inner ring), the precision class is an integer for class 4 and class 2 bearings only.

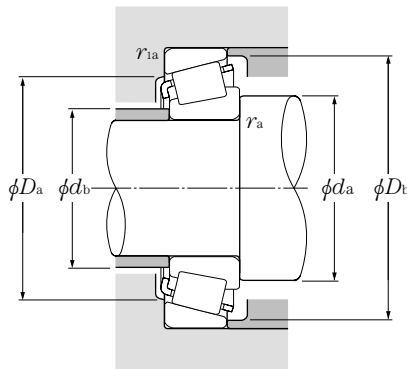

Equivalent radial load dynamic

$$P_r = XF_r + YF_a$$

$\frac{F_a}{F_r} \leq e$		$\frac{F_a}{F_r} > e$	
X	Y	X	Y
1	0	0.4	Y_2

static

$$P_{or} = 0.5F_r + Y_0F_a$$

When $P_{or} < F_r$ use $P_{or} = F_r$

For values of e , Y_2 and Y_0 see the table below.

Bearing numbers	Abutment and fillet dimensions						Load center mm	Constant e	Axial load factors		Mass kg (approx.)
	mm								a	Y_2	
	d_a	d_b	D_a	D_b	r_{as} max	r_{1as} max					
# 4T-JM207049/JM207010	64	62	85	91	1.5	2.5	7.6	0.33	1.79	0.99	0.82
4T-385/382A	65	61	89	92	2.3	0.8	3.1	0.35	1.69	0.93	0.616
# 4T-JH307749/JH307710	71	64	97	104	3	2.5	11.7	0.35	1.73	0.95	1.71
4T-28680/28622	68	62	88	92	3.5	0.8	3.3	0.40	1.49	0.82	0.774
4T-72218C/72487	80	67	102	116	3.5	3.3	-1.5 ¹⁾	0.74	0.81	0.45	1.99
4T-HM813840/HM813810	76	70	111	121	3.5	3.3	3.7	0.50	1.20	0.66	2.34
4T-389/382A	65	61	89	92	2.3	0.8	3.1	0.35	1.69	0.93	0.608
4T-387/382A	66	62	89	92	2.3	0.8	3.1	0.35	1.69	0.93	0.583
4T-387A/382A	69	62	89	92	3.5	0.8	3.1	0.35	1.69	0.93	0.581
4T-387AS/382A	72	62	89	92	5	0.8	3.1	0.35	1.69	0.93	0.576
4T-387S/382A	63	62	89	92	0.8	0.8	3.1	0.35	1.69	0.93	0.585
4T-28682/28622	70	63	88	92	3.5	0.8	3.3	0.40	1.49	0.82	0.747
4T-462/453X	67	63	92	98	2.3	3.3	7.1	0.34	1.79	0.98	1.06
4T-469/453X	70	63	92	98	3.5	3.3	7.1	0.34	1.79	0.98	1.06
4T-45289/45220	65	65	93	99	0.8	3.3	7.9	0.33	1.80	0.99	1.1
4T-469/453A	70	63	97	100	3.5	0.8	7.1	0.34	1.79	0.98	1.11
4T-390/394A	70	66	101	104	2.3	1.3	0.7	0.40	1.49	0.82	0.954
4T-469/454	70	63	96	100	3.5	2	7.1	0.34	1.79	0.98	1.24
4T-3979/3920	72	66	99	106	3.5	3.3	4.5	0.40	1.49	0.82	1.4
4T-39580/39520	72	66	101	107	3.5	3.3	6.6	0.34	1.77	0.97	1.41
4T-39581/39520	81	66	101	107	8	3.3	6.6	0.34	1.77	0.97	1.4
4T-33225/33462	74	68	104	112	3.5	3.3	2.6	0.44	1.38	0.76	1.58
4T-66225/66462	76	69	100	111	3.5	3.3	0.4	0.63	0.96	0.53	1.54
4T-623/612	72	66	105	110	3.5	3.3	14.4	0.31	1.91	1.05	2.12
4T-72225C/72487	81	67	102	116	3.5	3.3	-1.5 ¹⁾	0.74	0.81	0.45	1.96
4T-555S/552A	73	67	109	116	3.5	3.3	9.4	0.35	1.73	0.95	2.18
4T-78225/78551	83	77	117	132	3.5	2.3	-8.5 ¹⁾	0.87	0.69	0.38	2.69
4T-388A/382A	69	63	89	92	3.5	0.8	3.1	0.35	1.69	0.93	0.575
4T-66589/66520	74	73	105	116	0.8	3.3	-1.8 ¹⁾	0.67	0.90	0.50	1.66
4T-H913840†/H913810	88	82	124	138	3.5	3.3	-4.3 ¹⁾	0.78	0.77	0.42	3.22
# 4T-JLM508748/JLM508710	75	66	85	91	5	2.5	3.0	0.40	1.49	0.82	0.606
4T-29580/29520	75	68	96	103	3.5	3.3	0.6	0.46	1.31	0.72	0.992

Note: 3. Bearing numbers marked " # " designate **J-series** bearings. The tolerances of these bearings is listed in **Table 6.6** on **page A-42**.

1) " - " means that load center at outside on end of inner ring.

Inch series J series

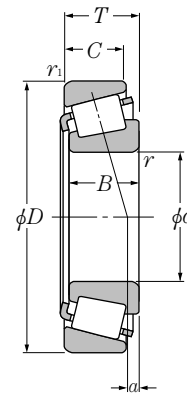

d 60.000 ~ 65.000mm

d	Boundary dimensions				dynamic kN	Basic load ratings			Limiting speeds	
	D	T	B	C		static	dynamic	static	grease	oil
	mm							kgf		min ⁻¹
					C _r	C _{or}	C _r	C _{or}		
60.000	110.000	22.000	21.996	18.824	89.5	120	9 150	12 300	3 200	4 300
	130.000	34.100	30.924	22.650	156.0	186	15 900	19 000	2 700	3 600
60.325	100.000	25.400	25.400	19.845	90.5	134	9 200	13 600	3 500	4 700
	112.712	30.162	30.048	23.812	119	174	12 200	17 800	3 200	4 300
	122.238	38.100	38.354	29.718	187	244	19 100	24 900	3 100	4 100
	122.238	43.658	43.764	36.512	194	283	19 700	28 900	3 100	4 100
	123.825	38.100	36.678	30.162	158	216	16 100	22 000	3 000	4 100
	127.000	36.512	36.512	26.988	163	228	16 600	23 300	2 900	3 800
	127.000	44.450	44.450	34.925	203	263	20 700	26 800	3 100	4 200
130.175	36.512	33.338	23.812	156	186	15 900	19 000	2 700	3 600	
61.912	110.000	22.000	21.996	18.824	89.5	120	9 150	12 300	3 200	4 300
	136.525	46.038	46.038	36.512	224	355	22 800	36 500	2 600	3 500
	146.050	41.275	39.688	25.400	199	234	20 300	23 900	2 400	3 200
61.976	101.600	24.608	24.608	19.845	90.5	134	9 200	13 600	3 500	4 700
62.738	101.600	25.400	25.400	19.845	90.5	134	9 200	13 600	3 500	4 700
63.500	94.458	19.050	19.050	15.083	60.5	103	6 150	10 500	3 600	4 800
	107.950	25.400	25.400	19.050	91.5	140	9 350	14 200	3 200	4 300
	107.950	25.400	25.400	19.050	91.5	140	9 350	14 200	3 200	4 300
	110.000	22.000	21.996	18.824	89.5	120	9 150	12 300	3 200	4 300
	110.000	25.400	25.400	19.050	91.5	140	9 350	14 200	3 200	4 300
	112.712	30.162	30.048	23.812	119	174	12 200	17 800	3 200	4 300
	112.712	30.162	30.162	23.812	138	195	14 100	19 800	3 200	4 200
	120.000	29.794	29.007	24.237	128	177	13 000	18 100	3 000	4 000
	120.000	29.794	29.007	24.237	128	177	13 000	18 100	3 000	4 000
	122.238	38.100	38.354	29.718	187	244	19 100	24 900	3 100	4 100
	122.238	43.658	43.764	36.512	194	283	19 700	28 900	3 100	4 100
	123.825	38.100	36.678	30.162	158	216	16 100	22 000	3 000	4 100
	127.000	36.512	36.170	28.575	163	229	16 600	23 300	2 900	3 800
	127.000	36.512	36.512	26.988	163	228	16 600	23 300	2 900	3 800
	136.525	41.275	41.275	31.750	194	262	19 800	26 700	2 800	3 800
140.030	36.512	33.236	23.520	171	212	17 400	21 600	2 600	3 400	
65.000	105.000	24.000	23.000	18.500	85.0	117	8 700	11 900	3 300	4 500
	110.000	28.000	28.000	22.500	119	174	12 200	17 800	3 200	4 300

Note: 1. Chamfer dimensions on the back face of the inner and outer rings of the bearing are larger than maximum values for installation dimensions r_{as} and r_{1as} .
2. Bearing numbers marked " # " designate J-series bearings. The accuracy of these bearings is listed in Table 6.6 on page A-42.

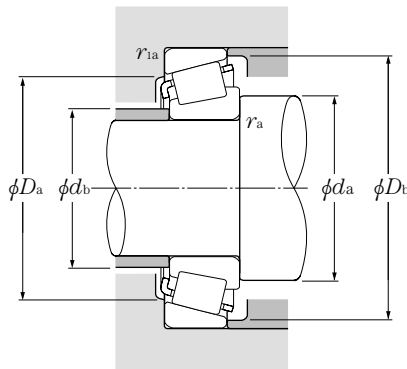

Equivalent radial load dynamic

$$P_r = XF_r + YF_a$$

$\frac{F_a}{F_r} \leq e$		$\frac{F_a}{F_r} > e$	
X	Y	X	Y
1	0	0.4	Y_2

static

$$P_{or} = 0.5F_r + Y_0F_a$$

When $P_{or} < F_r$ use $P_{or} = F_r$

For values of e , Y_2 and Y_0 see the table below.

Bearing numbers	Abutment and fillet dimensions						Load center mm	Constant e	Axial load factors		Mass kg (approx.)
	mm								a	e	
	d_a	d_b	D_a	D_b	r_{as} max	r_{1as} max					
4T-397/394A	69	68	101	104	0.8	1.3	0.7	0.40	1.49	0.82	0.91
# 4T-JHM911244/JHM911211	84	74	109	123	3.5	3.3	-7.6 ¹⁾	0.82	0.73	0.40	2.01
4T-28985/28921	73	67	89	96	3.5	3.3	2.5	0.43	1.41	0.78	0.772
4T-3980/3920	75	68	99	106	3.5	3.3	4.5	0.40	1.49	0.82	1.33
4T-HM212044/HM212011	85	70	108	116	8	3.3	11.1	0.34	1.78	0.98	2.02
4T-5583/5535	78	72	106	116	3.5	3.3	13.3	0.36	1.67	0.92	2.44
4T-558/552A	73	69	109	116	2.3	3.3	9.4	0.35	1.73	0.95	2.1
4T-HM813841/HM813810	80	73	111	121	3.5	3.3	3.7	0.50	1.20	0.66	2.21
4T-65237/65500	82	71	107	119	3.5	3.3	9.3	0.49	1.23	0.68	2.65
4T-HM911245/HM911210	87	74	109	124	5	3.3	-5.2 ¹⁾	0.82	0.73	0.40	2.12
4T-392/394A	70	69	101	104	0.8	1.3	0.7	0.40	1.49	0.82	0.879
4T-H715334/H715311	86	79	118	132	3.5	3.3	8.7	0.47	1.27	0.70	3.47
4T-H913842/H913810	90	82	124	138	3.5	3.3	-4.3 ¹⁾	0.78	0.77	0.42	3.17
4T-28990/28920	72	68	90	97	2	3.3	1.7	0.43	1.41	0.78	0.768
4T-28995/28920	75	69	90	97	3.5	3.3	2.5	0.43	1.41	0.78	0.764
4T-L610549/L610510	71	69	86	91	1.5	1.5	-0.6 ¹⁾	0.42	1.41	0.78	0.449
4T-29585/29520	77	71	96	103	3.5	3.3	0.6	0.46	1.31	0.72	0.924
4T-29586/29520	73	71	96	103	1.5	3.3	0.6	0.46	1.31	0.72	0.929
4T-390A/394A	73	70	101	104	1.5	1.3	0.7	0.40	1.49	0.82	0.851
4T-29585/29521	77	71	99	104	3.5	1.3	0.6	0.46	1.31	0.72	0.982
4T-3982/3920	77	71	99	106	3.5	3.3	4.5	0.40	1.49	0.82	1.26
4T-39585/39520	77	71	101	107	3.5	3.3	6.6	0.34	1.77	0.97	1.27
4T-477/472	73	72	107	114	0.8	2	3.9	0.38	1.56	0.86	1.49
4T-483/472	78	72	107	114	3.5	2	3.9	0.38	1.56	0.86	1.48
4T-HM212046/HM212011	80	73	108	116	3.5	3.3	11.1	0.34	1.78	0.98	1.95
4T-5584/5535	81	75	106	116	3.5	3.3	13.3	0.36	1.67	0.92	2.34
4T-559/552A	78	72	109	116	3.5	3.3	9.4	0.35	1.73	0.95	2.01
4T-565/563	80	73	112	120	3.5	3.3	8.3	0.36	1.65	0.91	2.11
4T-HM813842/HM813810	82	76	111	121	3.5	3.3	3.7	0.50	1.20	0.66	2.12
4T-639/632	81	74	118	125	3.5	3.3	11.4	0.36	1.66	0.91	2.85
4T-78250/78551	85	79	117	132	2.3	2.3	-8.5 ¹⁾	0.87	0.69	0.38	2.54
# 4T-JLM710949/JLM710910	77	71	96	101	3	1	0.3	0.45	1.32	0.73	0.742
# 4T-JM511946/JM511910	78	72	99	105	3	2.5	3.4	0.40	1.49	0.82	1.08

1) " - " means that load center at outside on end of inner ring.

Inch series J series

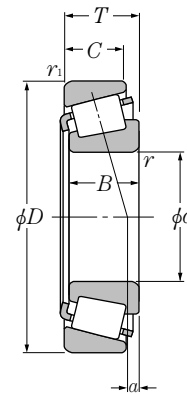

d 65.000 ~ 70.000mm

d	Boundary dimensions				dynamic kN	Basic load ratings			Limiting speeds	
	D	T	B	C		static	dynamic	static	grease	oil
	mm						kgf		min ⁻¹	
					C _r	C _{or}	C _r	C _{or}		
65.000	120.000	39.000	38.500	32.000	185	248	18 800	25 300	3 100	4 100
65.088	135.755	53.975	56.007	44.450	278	380	28 300	38 500	2 900	3 800
66.675	103.213	17.602	17.602	11.989	60.0	78.0	6 100	8 000	3 300	4 400
	107.950	25.400	25.400	19.050	91.5	140	9 350	14 200	3 200	4 300
	110.000	22.000	21.996	18.824	89.5	120	9 150	12 300	3 200	4 300
	112.712	30.162	30.048	23.812	119	174	12 200	17 800	3 200	4 300
	112.712	30.162	30.048	23.812	119	174	12 200	17 800	3 200	4 300
	112.712	30.162	30.162	23.812	138	195	14 100	19 800	3 200	4 200
	122.238	38.100	38.354	29.718	187	244	19 100	24 900	3 100	4 100
	123.825	38.100	36.678	30.162	158	216	16 100	22 000	3 000	4 100
	127.000	36.512	36.512	26.988	163	228	16 600	23 300	2 900	3 800
	130.175	41.275	41.275	31.750	194	262	19 800	26 700	2 800	3 800
135.755	53.975	56.007	44.450	278	380	28 300	38 500	2 900	3 800	
136.525	41.275	41.275	31.750	194	262	19 800	26 700	2 800	3 800	
136.525	41.275	41.275	31.750	226	293	23 100	29 900	2 700	3 700	
68.262	110.000	22.000	21.996	18.824	89.5	120	9 150	12 300	3 200	4 300
	120.000	29.794	29.007	24.237	128	177	13 000	18 100	3 000	4 000
	123.825	38.100	36.678	30.162	158	216	16 100	22 000	3 000	4 100
	136.525	41.275	41.275	31.750	226	293	23 100	29 900	2 700	3 700
	136.525	46.038	46.038	36.512	224	355	22 800	36 500	2 600	3 500
69.850	112.712	25.400	25.400	19.050	95.5	151	9 750	15 400	3 100	4 100
	117.475	30.162	30.162	23.812	117	175	11 900	17 900	3 000	4 000
	120.000	29.794	29.007	24.237	128	177	13 000	18 100	3 000	4 000
	120.000	32.545	32.545	26.195	147	214	15 000	21 800	3 000	4 000
	120.650	25.400	25.400	19.050	95.5	151	9 750	15 400	3 100	4 100
	127.000	36.512	36.170	28.575	163	229	16 600	23 300	2 900	3 800
	136.525	41.275	41.275	31.750	194	262	19 800	26 700	2 800	3 800
	146.050	41.275	41.275	31.750	206	295	21 000	30 000	2 500	3 300
	150.089	44.450	46.672	36.512	261	360	26 600	37 000	2 400	3 200
	168.275	53.975	56.363	41.275	340	460	34 500	46 500	2 200	3 000
69.952	121.442	24.608	23.012	17.462	91.0	127	9 300	13 000	2 900	3 800
70.000	110.000	26.000	25.000	20.500	97.0	150	9 900	15 300	3 200	4 200
	115.000	29.000	29.000	23.000	124	171	12 700	17 500	3 100	4 100

Note: 1. Chamfer dimensions on the back face of the inner and outer rings of the bearing are larger than maximum values for installation dimensions r_{as} and r_{1as} .
2. Bearing numbers marked " # " designate J-series bearings. The accuracy of these bearings is listed in Table 6.6 on page A-42.

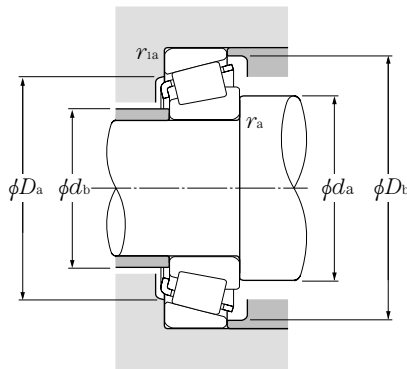

Equivalent radial load dynamic

$$P_r = XF_r + YF_a$$

$\frac{F_a}{F_r} \leq e$		$\frac{F_a}{F_r} > e$	
X	Y	X	Y
1	0	0.4	Y ₂

static

$$P_{or} = 0.5F_r + Y_0F_a$$

When $P_{or} < F_r$ use $P_{or} = F_r$

For values of e , Y_2 and Y_0 see the table below.

Bearing numbers	Abutment and fillet dimensions						Load center mm	Constant mm	Axial load factors		Mass kg
	mm								a	e	
	d_a	d_b	D_a	D_b	r_{as} max	r_{1as} max					(approx.)
# 4T-JH211749/JH211710	80	74	107	114	3	2.5	10.9	0.34	1.78	0.98	1.90
4T-6379/6320	84	77	117	126	3.5	3.3	18.8	0.32	1.85	1.02	3.71
4T-L812148/L812111	74	72	96	99	1.5	0.8	-3.7 ¹⁾	0.49	1.23	0.68	0.48
4T-29590/29520	80	73	96	103	3.5	3.3	0.6	0.46	1.31	0.72	0.86
4T-395A/394A	73	73	101	104	0.8	1.3	0.7	0.40	1.49	0.82	0.796
4T-3984/3925	80	74	101	106	3.5	0.8	4.5	0.40	1.49	0.82	1.19
4T-3994/3920	84	74	99	106	5.5	3.3	4.5	0.40	1.49	0.82	1.18
4T-39590/39520	80	74	101	107	3.5	3.3	6.6	0.34	1.77	0.97	1.19
4T-HM212049/HM212010	82	75	110	116	3.5	1.5	11.1	0.34	1.78	0.98	1.86
4T-560/552A	81	75	109	116	3.5	3.3	9.4	0.35	1.73	0.95	1.92
4T-HM813844/HM813810	85	78	111	121	3.5	3.3	3.7	0.50	1.20	0.66	2.03
4T-641/633	83	77	116	124	3.5	3.3	11.4	0.36	1.66	0.91	2.41
4T-6386/6320	87	77	117	126	4.3	3.3	18.8	0.32	1.85	1.02	3.64
4T-641/632	83	77	118	125	3.5	3.3	11.4	0.36	1.66	0.91	2.74
4T-H414242/H414210	85	81	121	129	3.5	3.3	11.0	0.36	1.67	0.92	2.75
4T-399A/394A	78	74	101	104	2.3	1.3	0.7	0.40	1.49	0.82	0.764
4T-480/472	82	75	107	114	3.5	2	3.9	0.38	1.56	0.86	1.37
4T-560S/552A	83	76	109	116	3.5	3.3	9.4	0.35	1.73	0.95	1.87
4T-H414245/H414210	86	82	121	129	3.5	3.3	11.0	0.36	1.67	0.92	2.7
4T-H715343/H715311	90	84	118	132	3.5	3.3	8.7	0.47	1.27	0.70	3.24
4T-29675/29620	80	77	101	109	1.5	3.3	-0.9 ¹⁾	0.49	1.23	0.68	0.949
4T-33275/33462	84	77	104	112	3.5	3.3	2.6	0.44	1.38	0.76	1.28
4T-482/472	83	77	107	114	3.5	2	3.9	0.38	1.56	0.86	1.33
4T-47487/47420	84	78	107	114	3.5	3.3	6.1	0.36	1.67	0.92	1.47
4T-29675/29630	80	77	104	113	1.5	3.3	-0.9 ¹⁾	0.49	1.23	0.68	1.17
4T-566/563	85	78	112	120	3.5	3.3	8.3	0.36	1.65	0.91	1.92
4T-643/632	86	80	118	125	3.5	3.3	11.4	0.36	1.66	0.91	2.63
4T-655/653	88	82	131	139	3.5	3.3	8.0	0.41	1.47	0.81	3.28
4T-745A/742	88	82	134	142	3.5	3.3	12.0	0.33	1.84	1.01	3.92
4T-835/832	91	84	149	155	3.5	3.3	18.5	0.30	2.00	1.10	6.13
4T-34274/34478	81	78	110	116	2	2	-1.2 ¹⁾	0.45	1.33	0.73	1.11
# 4T-JLM813049/JLM813010	78	77	98	105	1	2.5	-0.3 ¹⁾	0.49	1.23	0.68	0.889
# 4T-JM612949/JM612910	83	77	103	110	3	2.5	2.5	0.43	1.39	0.77	1.13

1) " - " means that load center at outside on end of inner ring.

Inch series
J series

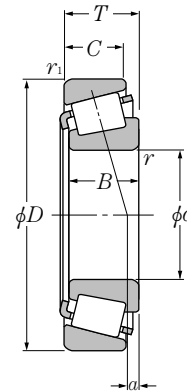

d 70.000 ~ 76.200mm

d	Boundary dimensions				dynamic kN	Basic load ratings			Limiting speeds	
	D	T	B	C		static	dynamic	static	grease	oil
	mm						kgf		min ⁻¹	
					C _r	C _{or}	C _r	C _{or}		
70.000	120.000	29.794	29.007	24.237	128	177	13 000	18 100	3 000	4 000
	150.000	41.275	39.688	25.400	199	234	20 300	23 900	2 400	3 200
71.438	117.475	30.162	30.162	23.812	117	175	11 900	17 900	3 000	4 000
	120.000	32.545	32.545	26.195	147	214	15 000	21 800	3 000	4 000
	127.000	36.512	36.170	28.575	163	229	16 600	23 300	2 900	3 800
	136.525	41.275	41.275	31.750	194	262	19 800	26 700	2 800	3 800
	136.525	41.275	41.275	31.750	226	293	23 100	29 900	2 700	3 700
73.025	112.712	25.400	25.400	19.050	95.5	151	9 750	15 400	3 100	4 100
	117.475	30.162	30.162	23.812	117	175	11 900	17 900	3 000	4 000
	127.000	36.512	36.170	28.575	163	229	16 600	23 300	2 900	3 800
	139.992	36.512	36.098	28.575	178	265	18 100	27 100	2 600	3 400
	149.225	53.975	54.229	44.450	287	410	29 300	41 500	2 500	3 400
73.817	112.712	25.400	25.400	19.050	95.5	151	9 750	15 400	3 100	4 100
	127.000	36.512	36.170	28.575	163	229	16 600	23 300	2 900	3 800
74.612	139.992	36.512	36.098	28.575	178	265	18 100	27 100	2 600	3 400
75.000	115.000	25.000	25.000	19.000	94.5	143	9 650	14 600	3 000	4 000
	120.000	31.000	29.500	25.000	131	197	13 300	20 100	2 900	3 900
	145.000	51.000	51.000	42.000	287	410	29 300	41 500	2 500	3 400
76.200	109.538	19.050	19.050	15.083	63.0	115	6 450	11 700	3 100	4 100
	121.442	24.608	23.012	17.462	91.0	127	9 300	13 000	2 900	3 800
	121.442	24.608	23.012	17.462	91.0	127	9 300	13 000	2 900	3 800
	127.000	30.162	31.000	22.225	135	194	13 800	19 800	2 800	3 700
	133.350	33.338	33.338	26.195	153	235	15 600	24 000	2 600	3 500
	133.350	39.688	39.688	32.545	177	305	18 000	31 000	2 600	3 500
	135.733	44.450	46.100	34.925	211	330	21 600	34 000	2 700	3 500
	136.525	30.162	29.769	22.225	129	189	13 200	19 300	2 600	3 500
	139.992	36.512	36.098	28.575	178	265	18 100	27 100	2 600	3 400
	139.992	36.512	36.098	28.575	178	265	18 100	27 100	2 600	3 400
	146.050	41.275	41.275	31.750	206	295	21 000	30 000	2 500	3 300
	149.225	53.975	54.229	44.450	287	410	29 300	41 500	2 500	3 400
	150.089	44.450	46.672	36.512	261	360	26 600	37 000	2 400	3 200

Note: 1. Chamfer dimensions on the back face of the inner and outer rings of the bearing are larger than maximum values for installation dimensions r_{as} and r_{1as} .
2. Bearing numbers marked " # " designate J-series bearings. The accuracy of these bearings is listed in Table 6.6 on page A-42.

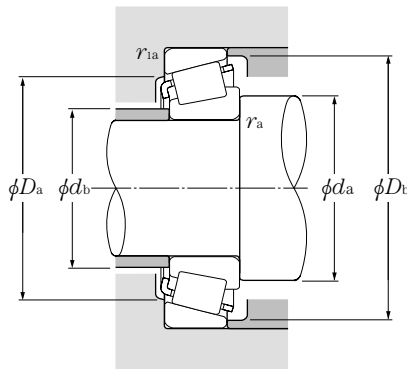

Equivalent radial load dynamic

$$P_r = XF_r + YF_a$$

$\frac{F_a}{F_r} \leq e$		$\frac{F_a}{F_r} > e$	
X	Y	X	Y
1	0	0.4	Y_2

static

$$P_{or} = 0.5F_r + Y_0F_a$$

When $P_{or} < F_r$ use $P_{or} = F_r$

For values of e , Y_2 and Y_0 see the table below.

Bearing numbers	Abutment and fillet dimensions						Load center mm	Constant e	Axial load factors		Mass kg (approx.)
	mm								a	e	
	d_a	d_b	D_a	D_b	r_{as} max	r_{1as} max					
4T-484/472	80	77	107	114	2	2	3.9	0.38	1.56	0.86	1.33
# 4T-JH913848/JH913811	92	82	126	146	2	3.3	-4.3 ¹⁾	0.78	0.77	0.42	3.08
4T-33281/33462	85	79	104	112	3.5	3.3	2.6	0.44	1.38	0.76	1.24
4T-47490/47420	86	79	107	114	3.5	3.3	6.1	0.36	1.67	0.92	1.42
4T-567A/563	86	80	112	120	3.5	3.3	8.3	0.36	1.65	0.91	1.87
4T-644/632	87	81	118	125	3.5	3.3	11.4	0.36	1.66	0.91	2.57
4T-H414249/H414210	89	83	121	129	3.5	3.3	11.0	0.36	1.67	0.92	2.58
4T-H715345/H715311	93	87	118	132	3.5	3.3	8.7	0.47	1.27	0.70	3.11
4T-29685/29620	86	80	101	109	3.5	3.3	-0.9 ¹⁾	0.49	1.23	0.68	0.873
4T-33287/33462	87	80	104	112	3.5	3.3	2.6	0.44	1.38	0.76	1.19
4T-567/563	88	81	112	120	3.5	3.3	8.3	0.36	1.65	0.91	1.82
4T-576/572	90	83	125	133	3.5	3.3	5.5	0.40	1.49	0.82	2.53
4T-6460/6420	93	87	129	140	3.5	3.3	14.8	0.36	1.66	0.91	4.42
4T-744/742	91	85	134	142	3.5	3.3	12.0	0.33	1.84	1.01	3.79
4T-29688/29620	83	80	101	109	1.5	3.3	-0.9 ¹⁾	0.49	1.23	0.68	0.86
4T-568/563	83	82	112	120	0.8	3.3	8.3	0.36	1.65	0.91	1.80
4T-577/572	91	85	125	133	3.5	3.3	5.5	0.40	1.49	0.82	2.48
# 4T-JLM714149/JLM714110	87	81	104	110	3	2.5	-0.3 ¹⁾	0.46	1.31	0.72	0.875
# 4T-JM714249/JM714210	88	83	108	115	3	2.5	1.9	0.44	1.35	0.74	1.29
# 4T-JH415647/JH415610	94	89	129	139	3	2.5	14.1	0.36	1.66	0.91	3.81
4T-L814749/L814710	84	82	100	105	1.5	1.5	-5.0 ¹⁾	0.50	1.20	0.66	0.579
4T-34300/34478	86	83	110	116	2	2	-1.2 ¹⁾	0.45	1.33	0.73	0.982
4T-34301/34478	89	83	110	116	3.5	2	-1.2 ¹⁾	0.45	1.33	0.73	0.977
4T-42687/42620	90	84	114	121	3.5	3.3	2.8	0.42	1.43	0.79	1.46
4T-47678/47620	97	85	119	128	6.4	3.3	3.9	0.40	1.48	0.82	1.92
4T-HM516442/HM516410	93	87	118	128	3.5	3.3	7.5	0.40	1.49	0.82	2.43
4T-5760/5735	94	88	119	130	3.5	3.3	11.0	0.41	1.48	0.81	2.75
4T-495A/493	92	86	122	130	3.5	3.3	0.7	0.44	1.35	0.74	1.83
4T-575/572	92	86	125	133	3.5	3.3	5.5	0.40	1.49	0.82	2.43
4T-575S/572	99	86	125	133	6.8	3.3	5.5	0.40	1.49	0.82	2.41
4T-659/653	93	87	131	139	3.5	3.3	8.0	0.41	1.47	0.81	3.04
4T-6461A/6420	108	89	129	140	9.7	3.3	14.8	0.36	1.66	0.91	4.23
4T-748S/742	93	87	134	142	3.5	3.3	12.0	0.33	1.84	1.01	3.66

1) " - " means that load center at outside on end of inner ring.

Inch series J series

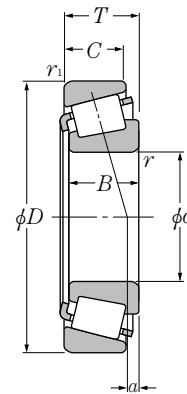

d 76.200 ~ 83.345mm

d	Boundary dimensions				dynamic kN	Basic load ratings			Limiting speeds	
	D	T	B	C		static	dynamic	static	grease	oil
	mm									min ⁻¹
					C _r	C _{or}	C _r	C _{or}		
							kgf			
76.200	149.225	53.975	54.229	44.450	287	410	29 300	41 500	2 500	3 400
	161.925	53.975	55.100	42.862	310	460	31 500	47 000	2 300	3 000
	180.975	53.975	53.183	35.720	325	415	33 000	42 500	1 900	2 600
	190.500	57.150	57.531	46.038	445	610	45 000	62 000	1 900	2 600
77.788	117.475	25.400	25.400	19.050	99.5	162	10 200	16 500	2 900	3 900
	121.442	24.608	23.012	17.462	91.0	127	9 300	13 000	2 900	3 800
	127.000	30.162	31.000	22.225	135	194	13 800	19 800	2 800	3 700
	136.525	30.162	29.769	22.225	129	189	13 200	19 300	2 600	3 500
	136.525	46.038	46.038	36.512	224	355	22 800	36 500	2 600	3 500
79.375	146.050	41.275	41.275	31.750	206	295	21 000	30 000	2 500	3 300
	161.925	47.625	48.260	38.100	270	385	27 500	39 000	2 300	3 100
	190.500	57.150	57.531	46.038	445	610	45 000	62 000	1 900	2 600
80.000	130.000	35.000	34.000	28.500	166	249	16 900	25 400	2 700	3 600
80.962	133.350	33.338	33.338	26.195	153	235	15 600	24 000	2 600	3 500
	136.525	30.162	29.769	22.225	129	189	13 200	19 300	2 600	3 500
	139.992	36.512	36.098	28.575	178	265	18 100	27 100	2 600	3 400
	150.089	44.450	46.672	36.512	261	360	26 600	37 000	2 400	3 200
82.550	125.412	25.400	25.400	19.845	102	163	10 400	16 600	2 700	3 600
	133.350	33.338	33.338	26.195	153	235	15 600	24 000	2 600	3 500
	133.350	39.688	39.688	32.545	177	305	18 000	31 000	2 600	3 500
	136.525	30.162	29.769	22.225	129	189	13 200	19 300	2 600	3 500
	139.992	36.512	36.098	28.575	178	265	18 100	27 100	2 600	3 400
	139.992	36.512	36.098	28.575	178	265	18 100	27 100	2 600	3 400
	146.050	41.275	41.275	31.750	206	295	21 000	30 000	2 500	3 300
	150.089	44.450	46.672	36.512	261	360	26 600	37 000	2 400	3 200
	152.400	39.688	36.322	30.162	180	279	18 300	28 400	2 300	3 100
	152.400	41.275	41.275	31.750	206	295	21 000	30 000	2 500	3 300
	161.925	47.625	48.260	38.100	270	385	27 500	39 000	2 300	3 100
	161.925	53.975	55.100	42.862	310	460	31 500	47 000	2 300	3 000
168.275	53.975	56.363	41.275	340	460	34 500	46 500	2 200	3 000	
83.345	125.412	25.400	25.400	19.845	102	163	10 400	16 600	2 700	3 600
	125.412	25.400	25.400	19.845	102	163	10 400	16 600	2 700	3 600
	125.412	25.400	25.400	19.845	102	163	10 400	16 600	2 700	3 600

Note: 1. Chamfer dimensions on the back face of the inner and outer rings of the bearing are larger than maximum values for installation dimensions r_{is} and r_{ios} .
 2. As for the maximum value for inner and outer ring diameters of bearings whose bearing numbers are marked with "+" (inner ring) and "++" (outer ring), the precision class is an integer for class 4 and class 2 bearings only.

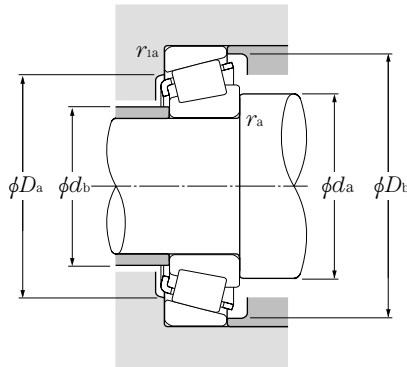

Equivalent radial load dynamic

$$P_r = XF_r + YF_a$$

$\frac{F_a}{F_r} \leq e$		$\frac{F_a}{F_r} > e$	
X	Y	X	Y
1	0	0.4	Y_2

static

$$P_{or} = 0.5F_r + Y_0F_a$$

When $P_{or} < F_r$ use $P_{or} = F_r$

For values of e , Y_2 and Y_0 see the table below.

Bearing numbers	Abutment and fillet dimensions						Load center mm	Constant e	Axial load factors		Mass kg (approx.)
	mm								a	e	
	d_a	d_b	D_a	D_b	r_{as} max	r_{1as} max					
4T-6461/6420	96	89	129	140	3.5	3.3	14.8	0.36	1.66	0.91	4.26
4T-6576/6535	99	92	141	154	3.5	3.3	12.8	0.40	1.50	0.82	5.44
4T-H917840/H917810††	110	100	152	170	3.5	3.3	-0.5 ¹⁾	0.73	0.82	0.45	6.57
4T-HH221430/HH221410	101	95	171	179	3.5	3.3	14.4	0.33	1.79	0.99	8.69
4T-LM814849/LM814810	91	85	105	113	3.5	3.3	-2.3 ¹⁾	0.51	1.18	0.65	0.932
4T-34306/34478	90	84	110	116	3.5	2	-1.2 ¹⁾	0.45	1.33	0.73	0.943
4T-42690/42620	91	85	114	121	3.5	3.3	2.8	0.42	1.43	0.79	1.41
4T-495AS/493	93	87	122	130	3.5	3.3	0.7	0.44	1.35	0.74	1.78
4T-H715348/H715311	98	88	118	132	3.5	3.3	8.7	0.47	1.27	0.70	2.84
4T-661/653	96	90	131	139	3.5	3.3	8.0	0.41	1.47	0.81	2.91
4T-756A/752	106	91	144	150	8	3.3	12.0	0.34	1.76	0.97	4.55
4T-HH221431/HH221410	103	97	171	179	3.5	3.3	14.4	0.33	1.79	0.99	8.52
# 4T-JM515649/JM515610	94	88	117	125	3	2.5	4.9	0.39	1.54	0.85	1.73
4T-47681/47620	95	89	119	128	3.5	3.3	3.9	0.40	1.48	0.82	1.78
4T-496/493	95	89	122	130	3.5	3.3	0.7	0.44	1.35	0.74	1.69
4T-581/572	96	90	125	133	3.5	3.3	5.5	0.40	1.49	0.82	2.26
4T-740/742	101	91	134	142	5	3.3	12.0	0.33	1.84	1.01	3.43
4T-27687/27620	96	89	115	120	3.5	1.5	-0.6 ¹⁾	0.42	1.44	0.79	1.07
4T-47686/47620	97	90	119	128	3.5	3.3	3.9	0.40	1.48	0.82	1.72
4T-HM516448/HM516410	105	92	118	128	6.8	3.3	7.5	0.40	1.49	0.82	2.16
4T-495/493	97	90	122	130	3.5	3.3	0.7	0.44	1.35	0.74	1.64
4T-580/572	98	91	125	133	3.5	3.3	5.5	0.40	1.49	0.82	2.2
4T-582/572	104	91	125	133	6.8	3.3	5.5	0.40	1.49	0.82	2.19
4T-663/653	99	92	131	139	3.5	3.3	8.0	0.41	1.47	0.81	2.78
4T-749A/742	99	93	134	142	3.5	3.3	12.0	0.33	1.84	1.01	3.37
4T-595/592A	100	93	135	144	3.5	3.3	2.6	0.44	1.36	0.75	3.02
4T-663/652	99	92	134	141	3.5	3.3	8.0	0.41	1.47	0.81	3.15
4T-757/752	100	94	144	150	3.5	3.3	12.0	0.34	1.76	0.97	4.42
4T-6559C/6535	104	98	141	154	3.5	3.3	12.8	0.40	1.50	0.82	5.09
4T-842/832	101	94	149	155	3.5	3.3	18.5	0.30	2.00	1.10	5.46
4T-27689/27620	90	90	115	120	0.8	1.5	-0.6 ¹⁾	0.42	1.44	0.79	1.06
4T-27690/27620	96	90	115	120	3.5	1.5	-0.6 ¹⁾	0.42	1.44	0.79	1.05
4T-27691/27620	102	90	115	120	6.4	1.5	-0.6 ¹⁾	0.42	1.44	0.79	1.04

Note: 3. Bearing numbers marked " # " designate **J-series** bearings. The tolerances of these bearings is listed in **Table 6.6** on **page A-42**.

1) " - " means that load center at outside on end of inner ring.

Inch series J series

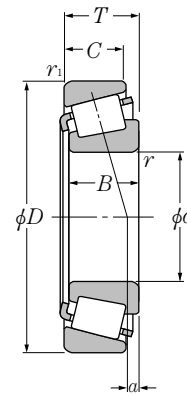

d 84.138 ~ 95.000mm

d	Boundary dimensions				dynamic kN	Basic load ratings			Limiting speeds	
	D	T	B	C		static	dynamic	static	grease	oil
	mm							kgf		min ⁻¹
					C _r	C _{or}	C _r	C _{or}		
84.138	136.525	30.162	29.769	22.225	129	189	13 200	19 300	2 600	3 500
85.000	130.000	30.000	29.000	24.000	135	214	13 700	21 900	2 600	3 500
	140.000	39.000	38.000	31.500	197	297	20 100	30 500	2 500	3 400
85.026	150.089	44.450	46.672	36.512	261	360	26 600	37 000	2 400	3 200
85.725	133.350	30.162	29.769	22.225	129	189	13 200	19 300	2 600	3 500
	142.138	42.862	42.862	34.133	216	350	22 000	35 500	2 500	3 300
	146.050	41.275	41.275	31.750	206	295	21 000	30 000	2 500	3 300
	152.400	39.688	36.322	30.162	180	279	18 300	28 400	2 300	3 100
	161.925	47.625	48.260	38.100	270	385	27 500	39 000	2 300	3 100
87.960	148.430	28.575	28.971	21.433	138	215	14 100	21 900	2 300	3 100
88.900	121.442	15.083	15.083	11.112	56.5	88.0	5 750	9 000	2 700	3 600
	123.825	20.638	20.638	16.670	80.0	141	8 150	14 400	2 700	3 500
	148.430	28.575	28.971	21.433	138	215	14 100	21 900	2 300	3 100
	152.400	39.688	36.322	30.162	180	279	18 300	28 400	2 300	3 100
	161.925	47.625	48.260	38.100	270	385	27 500	39 000	2 300	3 100
	161.925	53.975	55.100	42.862	310	460	31 500	47 000	2 300	3 000
	168.275	53.975	56.363	41.275	340	460	34 500	46 500	2 200	3 000
89.974	146.975	40.000	40.000	32.500	227	340	23 200	34 500	2 400	3 200
90.000	145.000	35.000	34.000	27.000	189	279	19 300	28 400	2 400	3 200
	155.000	44.000	44.000	35.500	270	385	27 500	39 000	2 300	3 100
	190.000	50.800	46.038	31.750	281	365	28 700	37 000	1 800	2 400
90.488	161.925	47.625	48.260	38.100	270	385	27 500	39 000	2 300	3 100
92.075	146.050	33.338	34.925	26.195	163	266	16 700	27 100	2 400	3 100
	152.400	39.688	36.322	30.162	180	279	18 300	28 400	2 300	3 100
	168.275	41.275	41.275	30.162	222	340	22 700	35 000	2 100	2 800
93.662	148.430	28.575	28.971	21.433	138	215	14 100	21 900	2 300	3 100
95.000	150.000	35.000	34.000	27.000	180	279	18 300	28 400	2 300	3 100

Note: 1. Chamfer dimensions on the back face of the inner and outer rings of the bearing are larger than maximum values for installation dimensions r_{is} and r_{ios} .
 2. As for the maximum value for inner and outer ring diameters of bearings whose bearing numbers are marked with "+" (inner ring) and "++" (outer ring), the precision class is an integer for class 4 and class 2 bearings only.

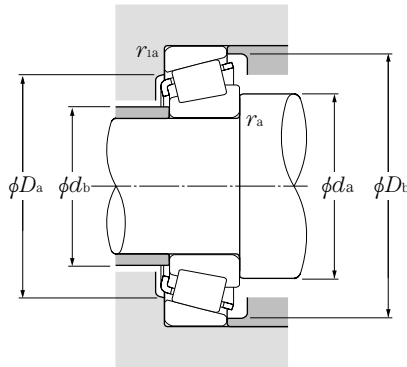

Equivalent radial load dynamic

$$P_r = XF_r + YF_a$$

$\frac{F_a}{F_r} \leq e$		$\frac{F_a}{F_r} > e$	
X	Y	X	Y
1	0	0.4	Y_2

static

$$P_{or} = 0.5F_r + Y_0F_a$$

When $P_{or} < F_r$ use $P_{or} = F_r$

For values of e , Y_2 and Y_0 see the table below.

Bearing numbers	Abutment and fillet dimensions						Load center mm	Constant e	Axial load factors		Mass kg (approx.)
	mm								a	e	
	d_a	d_b	D_a	D_b	r_{as} max	r_{1as} max					
4T-498/493	98	91	122	130	3.5	3.3	0.7	0.44	1.35	0.74	1.6
# 4T-JM716648/JM716610	104	92	117	125	6	2.5	0.2	0.44	1.35	0.74	1.37
# 4T-JHM516849/JHM516810	100	94	125	134	3	2.5	5.9	0.41	1.47	0.81	2.3
4T-749/742	101	95	134	142	3.5	3.3	12.0	0.33	1.84	1.01	3.25
4T-497/492A	99	93	120	128	3.5	3.3	0.7	0.44	1.35	0.74	1.43
4T-HM617049/HM617010	106	95	125	137	4.8	3.3	6.9	0.43	1.39	0.76	2.69
4T-665/653	102	95	131	139	3.5	3.3	8.0	0.41	1.47	0.81	2.65
4T-596/592A	102	96	135	144	3.5	3.3	2.6	0.44	1.36	0.75	2.9
4T-758/752	103	97	144	150	3.5	3.3	12.0	0.34	1.76	0.97	4.26
4T-42346/42584	103	98	134	142	3	3	-3.0 ¹⁾	0.49	1.22	0.67	1.99
4T-LL217849/LL217810	97	94	115	117	1.5	1.5	-2.9 ¹⁾	0.33	1.81	1.00	0.452
4T-L217849/L217810	97	94	116	119	1.5	1.5	-0.7 ¹⁾	0.33	1.82	1.00	0.737
4T-42350/42584	104	98	134	142	3	3	-3.0 ¹⁾	0.49	1.22	0.67	1.96
4T-593/592A	104	98	135	144	3.5	3.3	2.6	0.44	1.36	0.75	2.78
4T-759/752	106	99	144	150	3.5	3.3	12.0	0.34	1.76	0.97	4.09
4T-6580/6535	109	102	141	154	3.5	3.3	12.8	0.40	1.50	0.82	4.73
4T-850/832	106	100	149	155	3.5	3.3	18.5	0.30	2.00	1.10	5.08
4T-HM218248†/HM218210†	112	99	133	141	7	3.5	8.6	0.33	1.80	0.99	2.55
# 4T-JM718149/JM718110	105	99	131	139	3	2.5	2.0	0.44	1.35	0.74	2.14
# 4T-JHM318448/JHM318410	106	100	140	148	3	2.5	10.1	0.34	1.76	0.97	3.32
# 4T-J90354/J90748	120	112	162	179	3.5	3.3	-12.9 ¹⁾	0.87	0.69	0.38	6.32
4T-760/752	107	101	144	150	3.5	3.3	12.0	0.34	1.76	0.97	4.01
4T-47890/47820	107	101	131	140	3.5	3.3	0.6	0.45	1.34	0.74	2.08
4T-598A/592A	113	101	135	144	6.4	3.3	2.6	0.44	1.36	0.75	2.63
4T-681/672	110	104	149	160	3.5	3.3	3.0	0.47	1.28	0.70	3.87
4T-42368/42584	107	102	134	142	3	3	-3.0 ¹⁾	0.49	1.22	0.67	1.8
# 4T-JM719149/JM719113	109	104	135	143	3	2.5	1.7	0.44	1.36	0.75	2.19

Note: 3. Bearing numbers marked " # " designate **J-series** bearings. The tolerances of these bearings is listed in **Table 6.6** on **page A-42**.

1) " - " means that load center at outside on end of inner ring.

Inch series J series

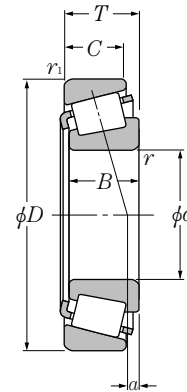

d 95.250 ~ 109.538mm

d	Boundary dimensions				dynamic kN	Basic load ratings			Limiting speeds	
	D	T	B	C		static	dynamic	static	grease	oil
	mm						kgf		min ⁻¹	
					C _r	C _{or}	C _r	C _{or}		
95.250	130.175	20.638	21.433	16.670	81.0	147	8 300	15 000	2 500	3 300
	146.050	33.338	34.925	26.195	163	266	16 700	27 100	2 400	3 100
	147.638	35.717	36.322	26.192	180	279	18 300	28 400	2 300	3 100
	148.430	28.575	28.971	21.433	138	215	14 100	21 900	2 300	3 100
	152.400	39.688	36.322	30.162	180	279	18 300	28 400	2 300	3 100
	157.162	36.512	36.116	26.195	188	305	19 200	31 000	2 200	2 900
	168.275	41.275	41.275	30.162	222	340	22 700	35 000	2 100	2 800
190.500	57.150	57.531	46.038	445	610	45 000	62 000	1 900	2 600	
96.838	148.430	28.575	28.971	21.433	138	215	14 100	21 900	2 300	3 100
	188.912	50.800	46.038	31.750	281	365	28 700	37 000	1 800	2 400
98.425	157.162	36.512	36.116	26.195	188	305	19 200	31 000	2 200	2 900
	168.275	41.275	41.275	30.162	222	340	22 700	35 000	2 100	2 800
99.974	212.725	66.675	66.675	53.975	575	810	58 500	82 500	1 700	2 300
100.000	155.000	36.000	35.000	28.000	192	310	19 600	31 500	2 200	2 900
100.012	157.162	36.512	36.116	26.195	188	305	19 200	31 000	2 200	2 900
101.600	157.162	36.512	36.116	26.195	188	305	19 200	31 000	2 200	2 900
	168.275	41.275	41.275	30.162	222	340	22 700	35 000	2 100	2 800
	180.975	47.625	48.006	38.100	285	430	29 100	44 000	2 000	2 700
	190.500	57.150	57.531	44.450	380	555	38 500	56 500	2 000	2 600
	190.500	57.150	57.531	46.038	445	610	45 000	62 000	1 900	2 600
	190.500	57.150	57.531	46.038	445	610	45 000	62 000	1 900	2 600
	212.725	66.675	66.675	53.975	475	695	48 500	71 000	1 800	2 300
212.725	66.675	66.675	53.975	575	810	58 500	82 500	1 700	2 300	
104.775	180.975	47.625	48.006	38.100	285	430	29 100	44 000	2 000	2 700
107.950	158.750	23.020	21.438	15.875	102	166	10 400	17 000	2 100	2 800
	159.987	34.925	34.925	26.988	167	320	17 100	33 000	2 100	2 800
	165.100	36.512	36.512	26.988	191	315	19 500	32 000	2 100	2 700
	212.725	66.675	66.675	53.975	475	695	48 500	71 000	1 800	2 300
109.538	158.750	23.020	21.438	15.875	102	166	10 400	17 000	2 100	2 800

Note: 1. Chamfer dimensions on the back face of the inner and outer rings of the bearing are larger than maximum values for installation dimensions r_{is} and r_{ios} .
 2. As for the maximum value for inner and outer ring diameters of bearings whose bearing numbers are marked with "+" (inner ring) and "++" (outer ring), the precision class is an integer for class 4 and class 2 bearings only.

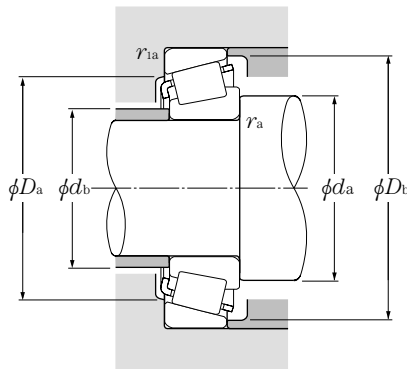

Equivalent radial load dynamic

$$P_r = XF_r + YF_a$$

$\frac{F_a}{F_r} \leq e$		$\frac{F_a}{F_r} > e$	
X	Y	X	Y
1	0	0.4	Y_2

static

$$P_{or} = 0.5F_r + Y_0F_a$$

When $P_{or} < F_r$ use $P_{or} = F_r$

For values of e , Y_2 and Y_0 see the table below.

Bearing numbers	Abutment and fillet dimensions						Load center mm	Constant e	Axial load factors		Mass kg (approx.)
	d_a	d_b	D_a	D_b	r_{as} max	r_{1as} max			Y_2	Y_0	
4T-L319249/L319210	103	101	122	125	1.5	1.5	-1.0 ¹⁾	0.35	1.72	0.95	0.789
4T-47896/47820	110	103	131	140	3.5	3.3	0.6	0.45	1.34	0.74	1.95
4T-594A/592XE	113	104	135	142	5	0.8	2.6	0.44	1.36	0.75	2.09
4T-42375/42584	108	103	134	142	3	3	-3.0 ¹⁾	0.49	1.22	0.67	1.75
4T-594/592A	110	104	135	144	3.5	3.3	2.6	0.44	1.36	0.75	2.51
4T-52375/52618	112	105	142	152	3.5	3.3	0.6	0.47	1.26	0.69	2.76
4T-683/672	113	106	149	160	3.5	3.3	3.0	0.47	1.28	0.70	3.72
4T-HH221440/HH221410	125	110	171	179	8	3.3	14.4	0.33	1.79	0.99	7.5
4T-42381/42584	110	104	134	142	3.5	3	-3.0 ¹⁾	0.49	1.22	0.67	1.69
4T-90381/90744	125	113	161	179	3.5	3.3	-12.9 ¹⁾	0.87	0.69	0.38	5.67
4T-52387/52618	114	108	142	152	3.5	3.3	0.6	0.47	1.26	0.69	2.62
4T-685/672	116	109	149	160	3.5	3.3	3.0	0.47	1.28	0.70	3.56
4T-HH224334†/HH224310	124	120	192	202	3.5	3.3	18.9	0.33	1.84	1.01	11.5
# 4T-JM720249/JM720210	115	109	140	149	3	2.5	-0.3 ¹⁾	0.47	1.27	0.70	2.4
4T-52393/52618	116	109	142	152	3.5	3.3	0.6	0.47	1.26	0.69	2.55
4T-52400/52618	117	111	142	152	3.5	3.3	0.6	0.47	1.26	0.69	2.48
4T-687/672	118	112	149	160	3.5	3.3	3.0	0.47	1.28	0.70	3.4
4T-780/772††	119	113	161	168	3.5	3.3	8.1	0.39	1.56	0.86	5.11
4T-861/854	129	114	170	174	8	3.3	15.3	0.33	1.79	0.99	7
4T-HH221449/HH221410	131	116	171	179	8	3.3	14.4	0.33	1.79	0.99	7.06
4T-HH221449A/HH221410	122	116	171	179	3.5	3.3	14.4	0.33	1.79	0.99	7.06
4T-941/932	130	117	187	193	7	3.3	19.7	0.33	1.84	1.01	11.2
4T-HH224335/HH224310	132	121	192	202	7	3.3	18.9	0.33	1.84	1.01	11.3
4T-782/772††	122	116	161	168	3.5	3.3	8.1	0.39	1.56	0.86	4.92
4T-37425/37625	122	115	143	152	3.5	3.3	-14.0 ¹⁾	0.61	0.99	0.54	1.37
4T-LM522546/LM522510	122	116	146	154	3.5	3.3	1.4	0.40	1.49	0.82	2.37
4T-56425/56650	123	117	149	159	3.5	3.3	-2.0 ¹⁾	0.50	1.21	0.66	2.69
4T-936/932	137	122	187	193	8	3.3	19.7	0.33	1.84	1.01	10.7
4T-37431/37625	123	116	143	152	3.5	3.3	-14.0 ¹⁾	0.61	0.99	0.54	1.33

Note: 3. Bearing numbers marked " # " designate **J-series** bearings. The tolerances of these bearings is listed in **Table 6.6** on **page A-42**.

1) " - " means that load center at outside on end of inner ring.

Inch series J series

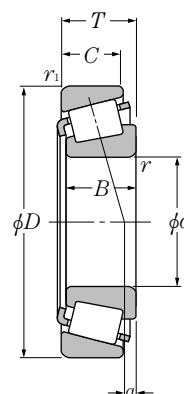

d 109.987 ~ 133.350mm

d	Boundary dimensions				dynamic kN	Basic load ratings			Limiting speeds	
	D	T	B	C		static	dynamic	static	grease	oil
109.987	159.987	34.925	34.925	26.988	167	320	17 100	33 000	2 100	2 800
109.992	177.800	41.275	41.275	30.162	232	375	23 600	38 000	1 900	2 600
110.000	165.000	35.000	35.000	26.500	191	315	19 500	32 000	2 100	2 700
	180.000	47.000	46.000	38.000	305	480	31 000	49 000	1 900	2 600
111.125	214.312	55.562	52.388	39.688	405	560	41 500	57 000	1 500	2 000
114.300	177.800	41.275	41.275	30.162	232	375	23 600	38 000	1 900	2 600
	180.975	34.925	31.750	25.400	169	245	17 200	25 000	1 900	2 500
	212.725	66.675	66.675	53.975	475	695	48 500	71 000	1 800	2 300
	212.725	66.675	66.675	53.975	575	810	58 500	82 500	1 700	2 300
	228.600	53.975	49.428	38.100	430	620	44 000	63 500	1 400	1 900
115.087	190.500	47.625	49.212	34.925	300	475	30 500	48 500	1 800	2 500
117.475	180.975	34.925	31.750	25.400	169	245	17 200	25 000	1 900	2 500
120.000	170.000	25.400	25.400	19.050	127	210	13 000	21 400	2 000	2 600
120.650	234.950	63.500	63.500	49.212	525	825	53 500	84 000	1 500	2 000
123.825	182.562	39.688	38.100	33.338	224	435	22 900	44 000	1 800	2 400
127.000	182.562	39.688	38.100	33.338	224	435	22 900	44 000	1 800	2 400
	196.850	46.038	46.038	38.100	310	550	31 500	56 500	1 700	2 200
	215.900	47.625	47.625	34.925	320	540	32 500	55 000	1 600	2 100
	228.600	53.975	49.428	38.100	320	445	32 500	45 000	1 400	1 900
	228.600	53.975	49.428	38.100	430	620	44 000	63 500	1 400	1 900
	230.000	63.500	63.500	49.212	525	825	53 500	84 000	1 500	2 000
	254.000	77.788	82.550	61.912	740	1 070	75 500	109 000	1 400	1 900
128.588	206.375	47.625	47.625	34.925	315	520	32 000	53 000	1 700	2 200
130.175	196.850	46.038	46.038	38.100	310	550	31 500	56 500	1 700	2 200
	206.375	47.625	47.625	34.925	315	520	32 000	53 000	1 700	2 200
133.350	177.008	25.400	26.195	20.638	126	259	12 900	26 400	1 800	2 400

Note: 1. Chamfer dimensions on the back face of the inner and outer rings of the bearing are larger than maximum values for installation dimensions r_{is} and r_{ios} .
 2. As for the maximum value for inner and outer ring diameters of bearings whose bearing numbers are marked with "+" (inner ring) and "++" (outer ring), the precision class is an integer for class 4 and class 2 bearings only.

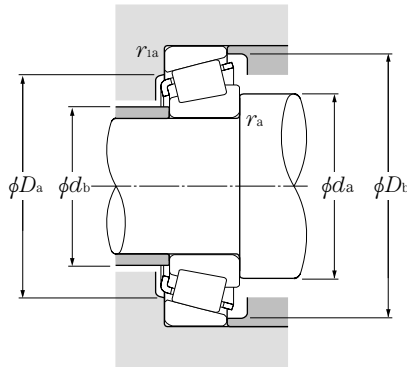

Equivalent radial load dynamic

$$P_r = XF_r + YF_a$$

$\frac{F_a}{F_r} \leq e$		$\frac{F_a}{F_r} > e$	
X	Y	X	Y
1	0	0.4	Y ₂

static

$$P_{or} = 0.5F_r + Y_0F_a$$

When $P_{or} < F_r$ use $P_{or} = F_r$

For values of e , Y_2 and Y_0 see the table below.

Bearing numbers	Abutment and fillet dimensions						Load center mm	Constant e	Axial load factors		Mass kg (approx.)
	mm								a	e	
	d_a	d_b	D_a	D_b	r_{as} max	r_{1as} max					
4T-LM522548/LM522510	133	118	146	154	8	3.3	1.4	0.40	1.49	0.82	2.24
4T-64433/64700	128	121	160	172	3.5	3.3	-1.1 ¹⁾	0.52	1.16	0.64	3.77
# 4T-JM822049/JM822010	124	119	149	159	3	2.5	-3.0 ¹⁾	0.50	1.21	0.66	2.52
# 4T-JHM522649/JHM522610	127	122	162	172	3	2.5	6.0	0.41	1.48	0.81	4.61
4T-H924045/H924010	139	131	186	205	3.5	3.3	-6.8 ¹⁾	0.67	0.89	0.49	8.18
4T-64450/64700	131	125	160	172	3.5	3.3	-1.1 ¹⁾	0.52	1.16	0.64	3.52
4T-68450/68712††	130	123	163	172	3.5	3.3	-5.4 ¹⁾	0.50	1.21	0.66	2.93
4T-938/932	141	128	187	193	7	3.3	19.7	0.33	1.84	1.01	10.1
4T-HH224346/HH224310	143	131	192	202	7	3.3	18.9	0.33	1.84	1.01	10.2
4T-HM926740/HM926710	146	142	200	219	3.5	3.3	-13.5 ¹⁾	0.74	0.81	0.45	9.76
4T-71453/71750	133	126	171	181	3.5	3.3	6.7	0.42	1.44	0.79	5.11
4T-68462/68712††	132	125	163	172	3.5	3.3	-5.4 ¹⁾	0.50	1.21	0.66	2.78
# 4T-JL724348/JL724314	132	127	156	163	3.3	3.3	-7.9 ¹⁾	0.46	1.31	0.72	1.67
4T-95475/95925	149	137	209	217	6.4	3.3	14.0	0.37	1.62	0.89	12.6
4T-48286/48220	139	133	168	176	3.5	3.3	5.7	0.31	1.97	1.08	3.52
4T-48290/48220	141	135	168	176	3.5	3.3	5.7	0.31	1.97	1.08	3.33
4T-67388/67322	144	138	180	189	3.5	3.3	6.3	0.34	1.74	0.96	5.1
4T-74500/74850	148	141	196	208	3.5	3.3	-2.2 ¹⁾	0.49	1.23	0.68	7.05
4T-97500/97900	151	144	197	213	3.5	3.3	-13.4 ¹⁾	0.74	0.81	0.45	8.43
4T-HM926747/HM926710	156	143	200	219	3.5	3.3	-13.5 ¹⁾	0.74	0.81	0.45	8.83
4T-95500/95905	154	142	207	217	6.4	3.3	14.0	0.37	1.62	0.89	12.9
4T-HH228349/HH228310	164	148	223	234	9.7	6.4	23.4	0.32	1.87	1.03	19.5
4T-799/792	146	140	186	198	3.3	3.3	1.9	0.46	1.31	0.72	5.77
4T-67389/67322	146	141	180	189	3.5	3.3	6.3	0.34	1.74	0.96	4.87
4T-799A/792	148	142	186	198	3.5	3.3	1.9	0.46	1.31	0.72	5.65
4T-L327249/L327210	142	140	167	171	1.5	1.5	-3.7 ¹⁾	0.35	1.72	0.95	1.7

Note: 3. Bearing numbers marked " # " designate **J-series** bearings. The tolerances of these bearings is listed in **Table 6.6** on **page A-42**.

1) " - " means that load center at outside on end of inner ring.

Inch series J series

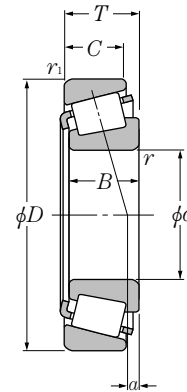

d 133.350 ~ 196.850mm

d	Boundary dimensions				dynamic kN	Basic load ratings			Limiting speeds	
	D	T	B	C		static	dynamic	static	grease	oil
	mm						kgf		min ⁻¹	
					C _r	C _{or}	C _r	C _{or}		
133.350	190.500	39.688	39.688	33.338	236	475	24 100	48 500	1 700	2 300
	196.850	46.038	46.038	38.100	310	550	31 500	56 500	1 700	2 200
	196.850	46.038	46.038	38.100	310	550	31 500	56 500	1 700	2 200
	215.900	47.625	47.625	34.925	320	540	32 500	55 000	1 600	2 100
	234.950	63.500	63.500	49.212	525	825	53 500	84 000	1 500	2 000
136.525	190.500	39.688	39.688	33.338	236	475	24 100	48 500	1 700	2 300
	228.600	57.150	57.150	44.450	445	735	45 500	75 000	1 500	2 000
139.700	215.900	47.625	47.625	34.925	320	540	32 500	55 000	1 600	2 100
	228.600	57.150	57.150	44.450	445	735	45 500	75 000	1 500	2 000
	254.000	66.675	66.675	47.625	550	910	56 000	92 500	1 400	1 800
142.875	200.025	41.275	39.688	34.130	239	490	24 300	50 000	1 600	2 100
	200.025	41.275	39.688	34.130	239	490	24 300	50 000	1 600	2 100
146.050	193.675	28.575	28.575	23.020	165	340	16 800	35 000	1 600	2 200
	254.000	66.675	66.675	47.625	550	910	56 000	92 500	1 400	1 800
152.400	192.088	25.000	24.000	19.000	130	261	13 200	26 700	1 600	2 100
	222.250	46.830	46.830	34.925	315	585	32 000	60 000	1 500	2 000
158.750	205.583	23.812	23.812	18.258	126	247	12 900	25 200	1 500	2 000
	225.425	41.275	39.688	33.338	254	555	25 900	56 500	1 400	1 900
165.100	225.425	41.275	39.688	33.338	254	555	25 900	56 500	1 400	1 900
170.000	230.000	39.000	38.000	31.000	282	520	28 700	53 000	1 400	1 800
177.800	227.012	30.162	30.162	23.020	181	415	18 500	42 000	1 300	1 800
	247.650	47.625	47.625	38.100	340	690	35 000	70 500	1 300	1 700
180.000	250.000	47.000	45.000	37.000	370	710	37 500	72 500	1 300	1 700
190.000	260.000	46.000	44.000	36.500	365	720	37 000	73 500	1 200	1 600
196.850	241.300	23.812	23.017	17.462	160	330	16 300	33 500	1 200	1 600

Note: 1. Chamfer dimensions on the back face of the inner and outer rings of the bearing are larger than maximum values for installation dimensions r_{as} and r_{1as} .
2. Bearing numbers marked " # " designate J-series bearings. The tolerances of these bearings is listed in Table 6.6 on page A-42.

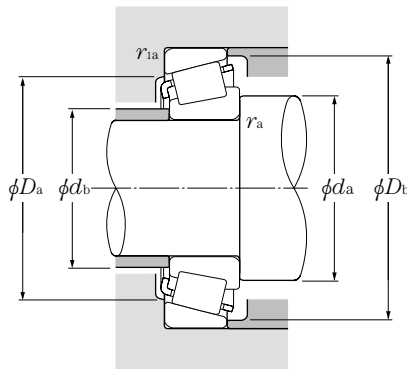

Equivalent radial load dynamic

$$P_r = XF_r + YF_a$$

$\frac{F_a}{F_r} \leq e$		$\frac{F_a}{F_r} > e$	
X	Y	X	Y
1	0	0.4	Y_2

static

$$P_{or} = 0.5F_r + Y_o F_a$$

When $P_{or} < F_r$ use $P_{or} = F_r$

For values of e , Y_2 and Y_o see the table below.

Bearing numbers	Abutment and fillet dimensions						Load center mm	Constant mm	Axial load factors		Mass kg (approx.)
	mm								a	e	
	d_a	d_b	D_a	D_b	r_{as} max	r_{1as} max					
4T-48385/48320	148	142	177	184	3.5	3.3	4.0	0.32	1.87	1.03	3.64
4T-67390/67322	149	143	180	189	3.5	3.3	6.3	0.34	1.74	0.96	4.63
4T-67391/67322	157	143	180	189	8	3.3	6.3	0.34	1.74	0.96	4.59
4T-74525/74850	152	146	196	208	3.5	3.3	-2.2 ¹⁾	0.49	1.23	0.68	6.56
4T-95525/95925	166	148	209	217	9.7	3.3	14.0	0.37	1.62	0.89	11.3
4T-48393/48320	151	144	177	184	3.5	3.3	4.0	0.32	1.87	1.03	3.43
4T-896/892	156	150	205	216	3.5	3.3	6.0	0.42	1.43	0.78	9.07
4T-74550/74850	158	151	196	208	3.5	3.3	-2.2 ¹⁾	0.49	1.23	0.68	6.05
4T-898/892	160	153	205	216	3.5	3.3	6.0	0.42	1.43	0.78	8.76
4T-99550/99100	170	156	227	238	7	3.3	12.1	0.41	1.47	0.81	14.3
4T-48684/48620	166	151	185	193	8	3.3	3.1	0.34	1.78	0.98	3.85
4T-48685/48620	158	151	185	193	3.5	3.3	3.1	0.34	1.78	0.98	3.89
4T-36690/36620	155	153	182	188	1.5	1.5	-5.0 ¹⁾	0.37	1.63	0.90	2.27
4T-99575/99100	175	162	227	238	7	3.3	12.1	0.41	1.47	0.81	13.5
4T-L630349/L630310	162	158	183	187	2	2	-10.0 ¹⁾	0.42	1.44	0.79	1.53
4T-M231648/M231610	178	163	207	213	8	1.5	5.9	0.33	1.8	0.99	5.72
4T-L432349/L432310	168	166	195	199	1.5	1.5	-9.8 ¹⁾	0.37	1.61	0.88	1.89
4T-46780/46720	176	169	209	218	3.5	3.3	-2.6 ¹⁾	0.38	1.57	0.86	5.2
4T-46790/46720	181	174	209	218	3.5	3.3	-2.6 ¹⁾	0.38	1.57	0.86	4.69
# 4T-JHM534149/JHM534110	184	178	217	224	3	2.5	-4.7 ¹⁾	0.38	1.57	0.86	4.37
4T-36990/36920	188	186	214	221	1.5	1.5	-12.8 ¹⁾	0.44	1.36	0.75	2.92
4T-67790/67720	194	188	229	240	3.5	3.3	-4.8 ¹⁾	0.44	1.36	0.75	6.57
# 4T-JM736149/JM736110	196	190	232	243	3	2.5	-9.0 ¹⁾	0.48	1.25	0.69	6.76
# 4T-JM738249/JM738210	206	200	242	252	3	2.5	-10.9 ¹⁾	0.48	1.26	0.69	6.85
4T-LL639249/LL639210	205	203	232	236	1.5	1.5	-17.3 ¹⁾	0.42	1.44	0.79	2.07

1) " - " means that load center at outside on end of inner ring.